



TOOL CATALOGUE

END OF FINANCIAL YEAR ISSUE

1 APRIL - 30 JUNE 2022



244PC CUSTOM SERIES METRIC/SAE TOOL KIT

680(W) x 460(D) x 1405(H)

- 1/4", 3/8" & 1/2" dr sockets & acc.
- Quad Drive ROE spanners
- Assorted screwdrivers & Hex Keys
- Pliers, cutters & Shifter
- Pin punch set
- Bit Driver set
- Hammers
- + MUCH MORE

OPTIONS AVAILABLE

STANDARD

\$2595

INCLUDES \$260*



SP50104

FOAMED

\$2695

INCLUDES \$270*



SP50104X

KIT INCLUDES 3 ADDITIONAL EVA FOAM TRAYS TO HELP KEEP YOUR KIT ORGANISED



* RECEIVE AN APPRENTICE CASH ONLINE E-VOUCHER VIA REDEMPTION TO USE TOWARDS TOOLS OF YOUR CHOICE ON YOUR NEXT PURCHASE AT SPTOOLS.COM



6 PT

1/2" DR DEEP IMPACT SOCKET SETS

AVAILABLE IN METRIC & SAE

- 15PC METRIC • 10 to 20, 21, 22 & 24mm
- 14PC SAE • 3/8 to 15/16 & 1"

NORMALLY \$239

\$99 EACH

SP20320

SP20325



12 PT

41PC 1/2" DR METRIC/SAE SOCKET SET

NORMALLY \$315

\$199 SP20300

- 10 to 26, 27, 30 & 32mm
- 3/8 to 1-1/4" • Spark Plug Sockets
- 45T Ratchet • Flex Handle
- Extension Bars • Universal Joint



PRO SERVICE TROLLEY 3 SHELF

- Adjustable middle tray - drop down or remove for more tray space

NORMALLY \$295

\$199 SP40019

- 2x Fixed & 2x lockable swivel castors
- 150kg Load Cap.



OWN QUALITY TOOLS AND EQUIPMENT TODAY AND PAY THEM OFF WEEKLY!



SPTOOLS.COM



MAX DRIVE CORDLESS

THE BEST AUTOMOTIVE POWER/INDUSTRIAL TOOLS AVAILABLE

12V CAULKING GUN 400ML

- Barrel size: 400ml
- Speed control function
- Patented dripless mechanism
- Patented rapid plunger release mechanism
- Cut-off switch when plunger reaches the end
- Works with all standard size cartridges



\$239

SP81362

INCLUDES 2X 2.0AH BATTERIES & CHARGER

12V 3/8" DR MINI IMPACT WRENCH KIT

TORQUE
105Nm

SPEED
2200RPM

KIT INCLUDES:

- 12v Mini 3/8" Dr Impact Wrench
- 10pc Metric Impact Socket Rail Set
- 2x 2.0Ah Max Lithium Battery Packs
- 12v Charger

\$299

SP81114

INCLUDES 2X 2.0AH BATTERIES & CHARGER



12V 3/8" DR MINI IMPACT WRENCH

TORQUE
105Nm

SPEED
2200RPM

- Variable speed switch with brake
- Ergonomic soft grip handle
- Includes 1x 2.0Ah battery & charger

\$229

SP81113

SKIN ONLY

\$175
SP81113BU



12V 1/4" HEX MINI IMPACT DRIVER

TORQUE
90Nm

SPEED
2200RPM

- Variable speed switch with brake
- Ergonomic soft grip handle
- Includes 1x 2.0Ah battery & charger

\$199

SP81141

SKIN ONLY

\$149
SP81141BU



12V 3/8" DR MINI RATCHET WRENCH

TORQUE
54Nm

SPEED
250RPM

- Compact design for tight access areas
- Reversible
- Includes 1x 2.0Ah battery & charger

\$299

SP81614



12V 10MM DRILL DRIVER

2 SPEED
L: 700RPM
H: 1700RPM

- Keyless Chuck
- 10 clutch torque selection
- Includes 1x 2.0Ah battery & charger

\$199

SP81213

SKIN ONLY

\$155
SP81213BU



16V RECIPROCATING SAW

**STROKE
LENGTH**
14mm

SPEED
3000SPM

- Fast cutting action up to 3000 strokes per minute
- 14mm stroke length

\$299

SP81354

SKIN ONLY

\$239
SP81354BU



16V GASKET SANDER

SPEED
8000RPM

- Pad size: 6.35mm (1/4")
- Powerful motor
- Includes 2x 3.0Ah battery & charger

\$299

SP81352

SKIN ONLY

\$225
SP81352BU



16V BELT SANDER

SPEED: 6500RPM

- Capacity (belt sizes): 460 x 10mm & 330 x 10mm

- 8 position versatile adjustable arm for ease of use in tight confined spaces

\$249

SP81350BU

SKIN ONLY

Battery & charger not included



16V 3/8" BRUSHLESS IMPACT WRENCH KIT

EXTREME TORQUE
392Nm

- No-Load Speed: 2300rpm

\$399

SP81120

PLUS 10PC 3/8" DR 6PT IMPACT SOCKET RAIL SET

INCLUDES 2X 3.0AH BATTERIES & CHARGER



18V 1/2" DR BRUSHLESS IMPACT WRENCH

INDUSTRY LEADER

> **970Nm** BOLT BUSTING TORQUE

> **2200RPM** NO LOAD SPEED



\$795
SP81134

AVAILABLE AS SKIN ONLY
\$549
SP81133BU

- Capacity: 1/2" (13mm)
- Variable speed switch with brake
- Powerful brushless motor
- Lightweight & Compact
- Compact design - Only 169mm long (Including anvil)
- Reversible
- Ergonomic soft grip handle

INCLUDES 2X 5.0AH BATTERY PACKS & CHARGER



WATCH THE DEMO VIDEO

SCAN ME



CUSTOMER TESTIMONIALS

"RATTLE GUN AND A MOTORSPORT TOOL KIT STILL GOING 6 YEARS ON"

- Brandon McQueen

"7 YEARS OLD AND STILL GOING STRONG"

- Kris Henery

"UNBREAKABLE TOOLS, I LOVE IT"

- Charnino Espinosa

"IT'S A BLOODY TOUGH LITTLE THING THAT'S WORKED IT'S GUTS OUT."

- Adon Yates

BRUSHLESS TECHNOLOGY

SP Maxdrive Brushless motors provide more runtime and superior power when compared to other leading brands. Using the highest quality components and industry best manufacturing process, we deliver the power that you need.... SP Maxdrive

18V IMPACT WRENCHES

- Variable speed switch with brake
- Powerful motor
- Ergonomic soft grip handle

1/2" DR

BOLT BUSTING TORQUE 1490Nm



\$899

SP81130

Includes 2x 5.0Ah Batteries & Charger

3/4" DR

BOLT BUSTING TORQUE 1788Nm



\$899

SP81140

Includes 2x 5.0Ah Batteries & Charger

18V INDUSTRIAL GREASE GUN

PRESSURE 10,000PSI

CARTRIDGE 450cc

FLOW RATE HIGH: 280g p/m LOW: 100g p/m

HIGH CAPACITY PER CHARGE 18x 450ml tubes in high setting 11x 450ml tubes in low setting

MORE EFFICIENT LUBRICATION



\$649

SP81523

INCLUDES 1X 2.0AH BATTERY & CHARGER

18V INDUSTRIAL RIVETER

PULLING FORCE 2000Kg

HIGH CAPACITY ± 1300 rivets on one charge

- Sets ± 1300 rivets on one charge (650 stainless 6.4mm rivets off 1x 5.0ah battery charge)
- Powerful brushless motor
- Suits all materials - aluminium, steel & stainless steel
- Includes interchangeable nozzles
- Attached collection bottle

SETS RIVET SIZES



\$799

SP81376

ALSO AVAILABLE IN SKIN ONLY

\$575
SP81376BU

18V 1/4" HEX BRUSHLESS IMPACT DRIVER

EXTREME CONTROL
More control means reduced over driving, breaking and stripping of screws

\$399

SP81147

INCLUDES 2X 5.0AH BATTERIES & CHARGER

SKIN ONLY \$239
SP81147BU

SP MAX DRIVE GIVES YOU 3 SPEEDS AND 2 TORQUE SETTINGS FOR ALL APPLICATIONS

SETTING 1: RPM 0-900 - IPM 0-1000 - TORQUE 10.7NM
SETTING 2: RPM 0-2100 - IPM 0-2900 - TORQUE 98NM
SETTING 3: RPM 0-3000 - IPM 0-4000 - TORQUE 205NM
REVERSE: RPM 0-3000 - IPM 0-4000 - TORQUE 205NM



SP TOOLS HAS TRADIES COVERED

SIMPLY PURCHASE A 'TRADIE CASH' MARKED PRODUCT AND RECEIVE AN ONLINE VOUCHER TO SPEND AT WWW.SPTOOLS.COM
Visit sptools.com for full terms & conditions.

REDEEMING IS QUICK AND EASY.

VISIT OUR APPRENTICE PAGE AT SPTOOLS.COM FOR MORE INFORMATION

TOOL KITS

437PC SUMO SERIES ROLLER CABINET TOOL KIT

METRIC & SAE

1434w x 560d x 1074h (mm)

12 DRAWER

- 1/4", 3/8" & 1/2" Dr sockets & access.
- Quad Drive ROE spanners
- Screwdriver & hex key sets
- Pliers, cutters & pry bar set
- Pin punches & chisels
- + MUCH MORE

Built-in power board with 4 individually switched power outlets and 4 USB ports, adjustable shelf and deep drawer



SP50780

\$4750

\$475 APPRENTICE CASH

FULL LENGTH TOP DRAWER

POWER TOOL CUPBOARD

BUILT-IN POWER BOARD

DEEP INTERNAL DRAWER

SP EASY CREDIT

STAINLESS STEEL WORK TOP

1434mm

560mm

1090mm



INCLUDES QUAD DRIVE SPANNERS

SP EASY CREDIT

205PC CUSTOM SERIES TOOL KIT METRIC/SAE

668(W) x 316(D) x 461(H)

\$1195

SP50099



INCLUDES QUAD DRIVE SPANNERS

SP EASY CREDIT

218PC CUSTOM SERIES TOOL KIT METRIC/SAE

668(W) x 445(D) x 465(H)

\$1450

SP50121



INCLUDES QUAD DRIVE SPANNERS

\$170

APPRENTICE CASH

SP EASY CREDIT

254PC CUSTOM SERIES TOOL KIT METRIC/SAE

668(W) x 445(D) x 465(H)

\$1695

SP50123



ALSO AVAILABLE

THIS KIT IS ALSO AVAILABLE WITH A 7 DRAWER ROLL CAB

\$2895

SP50039D

INCLUDES QUAD DRIVE SPANNERS

212PC TECH SERIES TOOL KIT METRIC ONLY

730(W) x 480(D) x 507(H)

\$1895

SP50033D



INCLUDES QUAD DRIVE & FLARE NUT SPANNERS

25% THICKER STEEL

281PC TECH SERIES TOOL KIT METRIC/SAE

730(W) x 480(D) x 507(H)

\$2150

SP52255D



25% THICKER STEEL

INCLUDES QUAD DRIVE SPANNERS

230PC TECH SERIES ROLL CAB TOOL KIT - METRIC ONLY

745(W) x 480(D) x 870(H)

\$2195

SP52525D

OWN QUALITY TOOLS AND EQUIPMENT TODAY AND PAY THEM OFF WEEKLY!

REPAYMENTS START FROM ONLY \$8 PER WEEK



SP EASY CREDIT CAN HELP YOU FINANCE YOUR SP TOOLS PURCHASE OVER THE COMBINED VALUE OF \$1000 AND REPAYMENTS START FROM AS LITTLE AS \$8 PER WEEK*.

APPLY NOW AT SPTOOLS.COM

Morris Finance Ltd: ABN 70 083 630 139 Australian Credit Licence: 395 249 - *Weekly payments for the Tools of the Trade payment plans are based on approximately \$1000 investment financed over 4 years. These payments are an indication only and variables such as loan type, applicant profile and current interest rates are not taken into account. Exact payments will be provided on application. For approved applicants only, terms and conditions apply.



413PC
OFF ROAD SERIES
TOOL KIT METRIC/SAE
 890(W) x 510(D) x 615(H)
STANDARD \$325
\$3250

APPRENTICE CASH EACH
 AVAILABLE IN 2 COLOURS:
 SP50115 Black
 SP50115W White

FOAMED \$335
\$3350
APPRENTICE CASH EACH
 AVAILABLE IN 2 COLOURS:
 SP50115X Black
 SP50115WX White



410PC
OFF ROAD SERIES FIELD
SERVICE TOOL KIT
METRIC/SAE
 729(W) x 508(D) x 660(H)

INCLUDES
 Jumbo 3/4" Dr Sockets up
 to 55mm & 1-7/8"



\$440
APPRENTICE CASH

\$4395
SP50218

66PC STARTER TOOL KIT
888 SERIES

510w x 200d x 210h (mm)
 • Heavy duty steel tool box
 • Spanners, sockets & accessories
 are housed in hi-density EVA
 foam storage tray
 • Extra large volume storage
 compartment

KIT INCLUDES
 • 1/2" Dr Sockets &
 accessories
 • ROE spanner set
 • Screwdrivers
 • Pliers & cutters
 + MUCH MORE

Dimensions:
 • Tote Tray: 475w x 170d x 45h
 • Base Compartment:
 510w x 200dx 145h

\$299
T850090



TOOL KITS IN X-CASES
METRIC/SAE

AVAILABLE IN 3/8" DR & 1/2" DR

• Ideal for the professional on the
 move or as a handy kit for the car

MODEL	PIECES	DRIVE
SP51204	65pc	3/8" Dr
SP51205	60pc	1/2" Dr

KITS INCLUDE
 • Sockets & accessories
 • Quad Drive spanners - 8 to 19mm
 • Screwdrivers & hex keys
 • Pliers & cutters



\$329
EACH

XCASE
 HEAVY DUTY LONG LASTING STORAGE



OPTIONS AVAILABLE
 THIS KIT IS ALSO
 AVAILABLE WITH
 ADDITIONAL EVA
 FOAM TRAYS



INCLUDES
 QUAD DRIVE
 SPANNERS

STEEL FRAME

293PC
CUSTOM SERIES TOOL KIT
METRIC/SAE
 680(W) x 460(D) x 1405(H)

STANDARD \$275
\$2750
APPRENTICE CASH SP50125

FOAMED \$280
\$2795
APPRENTICE CASH SP50125X



OPTIONS AVAILABLE
 THIS KIT IS ALSO
 AVAILABLE WITH
 ADDITIONAL EVA
 FOAM TRAYS

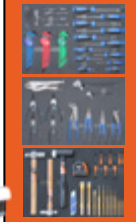

INCLUDES
 QUAD DRIVE,
 FLARE NUT &
 DOUBLE RING
 SPANNERS

STEEL FRAME

370PC
CUSTOM SERIES TOOL KIT
METRIC/SAE
 680(W) x 460(D) x 1405(H)

STANDARD \$375
\$3750
APPRENTICE CASH SP50110

FOAMED \$385
\$3850
APPRENTICE CASH SP50110X



KIT INCLUDES
 QUAD DRIVE, GEAR
 DRIVE, FLARE NUT,
 E-TORX & DOUBLE
 RING SPANNERS



PLUS
 STANDARD, DEEP,
 IMPACT, TORX,
 INHEX, E-TORX,
 IMPACT INHEX,
 IMPACT TORX
 & SPARK PLUG
 SOCKETS

OPTIONS AVAILABLE
 THIS KIT IS ALSO
 AVAILABLE
 WITH
 ADDITIONAL
 EVA FOAM
 TRAYS

STEEL FRAME

625PC
CUSTOM SERIES TOOL KIT
METRIC/SAE
 680(W) x 460(D) x 1405(H)

STANDARD \$550
\$5495
APPRENTICE CASH SP50165

FOAMED \$560
\$5595
APPRENTICE CASH SP50165X

TOOL KITS



HOT DEAL

NEW

237PC CUSTOM SERIES ROLLER CABINET TOOL KIT WITH SIDE CABINET

1596(W) x 480(D) x 1070(H)

- 1/4", 3/8" & 1/2" dr sockets & acc.
- Quad Drive ROE spanners
- Assorted screwdrivers & Hex Keys
- Pliers, cutters & Shifter
- Pin punch set
- Bit Driver set
- Hammers
- + MUCH MORE

3 MORE COLOUR OPTIONS AVAILABLE



SP50626X SP50626BLX SP50626GX

\$2595

EACH

SP50626DX

BLACK / GREY

ADJUSTABLE CABINET SHELF

HEAVY DUTY DRAWER SLIDES

EXTRA DEEP BOTTOM DRAWER

FULL EXTENSION DRAWERS

HEAVY DUTY CASTORS

EVA TOOL STORAGE

QUAD DRIVE SPANNERS



25% THICKER STEEL

DOG BONE FRAME

OPTIONS AVAILABLE

THIS KIT IS ALSO AVAILABLE WITH ADDITIONAL EVA FOAM TRAYS



INCLUDES QUAD DRIVE & FLARE NUT SPANNERS



282PC TECH SERIES TOOL KIT METRIC/SAE

745(W) x 480(D) x 1520(H)

STANDARD \$300 **\$2995**

FOAMED \$310 **\$3095**

APPRENTICE CASH SP52265D

APPRENTICE CASH SP52265DX



SUMO SERIES POWER HUTCH TOOL KITS METRIC/SAE

1066(W) x 480(D) x 1610(H)

INCLUDES QUAD DRIVE SPANNERS



OPTIONS AVAILABLE

THIS KIT IS ALSO AVAILABLE WITH ADDITIONAL EVA FOAM TRAYS

AVAILABLE IN 333PC & 547PC KITS

333 PIECE \$490 **\$4895**

APPRENTICE CASH SP50553

547 PIECE \$590 **\$5895**

APPRENTICE CASH SP50557

FOAMED \$500 **\$4995**

APPRENTICE CASH SP50553X

FOAMED \$600 **\$5995**

APPRENTICE CASH SP50557X



30% WIDER STORAGE

417PC SUMO SERIES TOOL KIT METRIC/SAE

853(W) x 460(D) x 1406(H) mm

OPTIONS AVAILABLE

THIS KIT IS ALSO AVAILABLE WITH ADDITIONAL EVA FOAM TRAYS



AVAILABLE IN 2 ADDITIONAL COLOUR OPTIONS



INCLUDES QUAD DRIVE SPANNERS



STANDARD \$390 **\$3895**

APPRENTICE CASH EACH

SP50175 Solid Black
SP50176 Black/Blue
SP50177 Black/Green

FOAMED \$400 **\$3995**

APPRENTICE CASH EACH

SP50175X Solid Black
SP50176X Black/Blue
SP50177X Black/Green



ARE YOU AN APPRENTICE?

SIMPLY PURCHASE AN 'APPRENTICE CASH' MARKED PRODUCT AND RECEIVE AN ONLINE VOUCHER TO SPEND AT WWW.SPTOOLS.COM
Visit sptools.com for full terms & conditions.

REDEEMING IS QUICK AND EASY. VISIT OUR APPRENTICE PAGE AT SPTOOLS.COM FOR MORE INFORMATION



AVAILABLE IN
3 COLOUR
OPTIONS

- SP44890
- SP44890BL
- SP44890G

\$12,990

EACH

128" COMPLETE WORKSTATION

COMBINED DIMENSIONS: 3250w x 622d x 1954h (mm)

COMPLETE WORKSTATION INCLUDES:

73" USA SUMO 21 Drawer Roller Cabinet & Power Top Hutch & 2x 27" Side Cabinets

CUSTOMISE YOUR OWN STORAGE SOLUTION

SP makes it easy to expand your tool kits storage. Start with a roller cab or roll cab hutch combo and add side cabinets when the time comes for more storage space.

**73" POWER TOP HUTCH
SHELF/LIGHT/PEGBOARD**

1850(W) x 622(D) x 864(H)

B

**59" POWER TOP HUTCH
SHELF/LIGHT/PEGBOARD**

1500(W) x 622(D) x 864(H)



- Includes up to 2x magnetic mount power boards
- Includes up to 2x 600mm LED lights

- SP44830
- SP44830BL
- SP44830G

\$2995

EACH

- SP44730
- SP44730BL
- SP44730G

\$2475

EACH

**59" WORKSHOP
ROLLER CABINET
13 DRAWER**

\$4500

EACH



- SP44725 Black/Chrome
- SP44725BL Blue/Black
- SP44725G Green/Black

1500(W) x 622(D) x 1090(H)

- | | | | | |
|-----------------------------|-----------------------|----------------------------|---------------------------|--------------------------------|
| 13 DRAWER
ROLLER CABINET | DOUBLE DRAWER
BANK | STAINLESS STEEL
WORKTOP | FULL LENGTH
TOP DRAWER | EXTREME DUTY
SPRING CASTORS |
|-----------------------------|-----------------------|----------------------------|---------------------------|--------------------------------|

**27" SIDE CABINET
CLOTHES RAIL & FIXED SHELVES**

700(W) x 622(D) x 1954(H)

A

- SP44885
- SP44885BL
- SP44885G

\$2295

EACH

- Side cabinets can be used on either side of the hutch and roll cab combo



**27" SIDE CABINET
4 ROLLER SHELVES & 1 FIXED**

700(W) x 622(D) x 1954(H)

D

- SP44880
- SP44880BL
- SP44880G

\$2495

EACH

**73" WORKSHOP
ROLLER CABINET
21 DRAWER**

\$5995

EACH

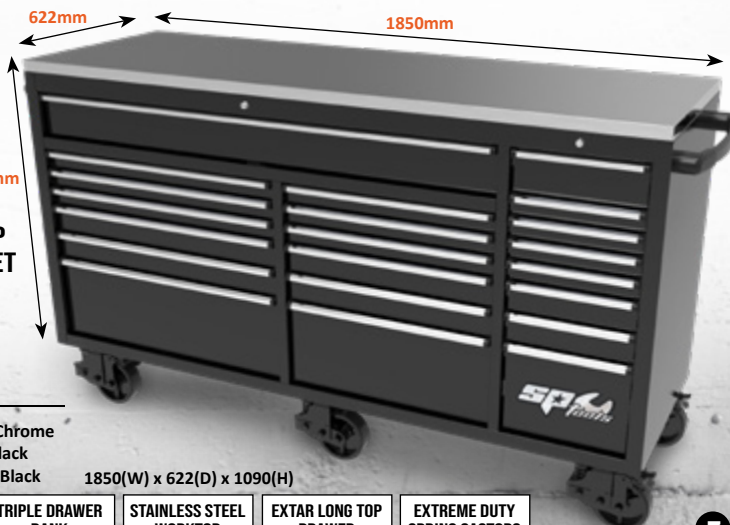

- SP44825 Black/Chrome
- SP44825BL Blue/Black
- SP44825G Green/Black

1850(W) x 622(D) x 1090(H)

- | | | | | |
|-----------------------------|-----------------------|----------------------------|--------------------------|--------------------------------|
| 21 DRAWER
ROLLER CABINET | TRIPLE DRAWER
BANK | STAINLESS STEEL
WORKTOP | EXTAR LONG TOP
DRAWER | EXTREME DUTY
SPRING CASTORS |
|-----------------------------|-----------------------|----------------------------|--------------------------|--------------------------------|

STORAGE



SUMO SERIES POWER HUTCH TOOL BOX & ROLL CAB COMBO

18 DRAWER

1066w x 480d x 1610h (mm)

- Built in surge protected power-board with 4 power outlets and 4 USB ports, ideal for power tools, chargers, etc
- Steel pegboard rear wall to organise frequently used tools
- SP Kliklok on all drawers ensures drawers stay closed and secure
- Anti-slip matting in Hutch.
- Full drawer extension capability

\$2495

SP40698

HOT DEAL

NEW

\$1250

EACH

CUSTOM SERIES ROLL CAB WITH SIDE CABINET

11 DRAWER

1596w x 480d x 1070h (mm)



BLACK GREY SP40160D

3 MORE COLOUR OPTIONS AVAILABLE



SP40160

SP40160BL

SP40160G



OFF ROAD SERIES FIELD SERVICE BOX

7 DRAWER

890w x 510d x 615h

- Full roll cage protection
- Drop down security front panel
- Skid rail base provides reinforcement and extra protection
- Lifting handles ideal for lifting slings
- Double Powder coating



\$999

EACH

AVAILABLE IN 2 COLOURS:

SP40322 Black
SP40321 White

\$100



TECH SERIES ROLL CAB

13 DRAWER

1145w x 480d x 1030h (mm)

- Stainless steel worktop
- Heavy duty castors - 2x lockable swivel
- Paper towel holder
- Side storage compartment/bin
- SP Kliklok drawer locking system
- Internal locking system
- Side storage compartments

\$200



\$1995

EACH



BLACK GREY

SP42355D

SP42355BL

SP42355G

STACKABLE STORAGE



30%
WIDER STORAGE

SUMO SERIES

7 DRAWER TOOL BOX

841w x 445d x 462h (mm)

- Internal locking system
- Heavy duty 28 ball bearing drawer slides
- Robust wall construction
- Double powder coating
- Full drawer extension capabilities

\$749

EACH

SP40120
SP40121
SP40122

7 DRAWER ROLL CAB

853w x 460d x 779h (mm)

- Internal locking system for extra security
- Heavy duty 28 ball bearing drawer slides
- Robust wall construction
- Double powder coating
- Full drawer extension capabilities
- Heavy duty castors - 2x lockable swivel

\$1150

EACH

SP40125
SP40126
SP40127



CUSTOM SERIES

7 DRAWER TOOL BOX

668w x 316d x 461h (mm)

- Internal locking system
- Heavy duty 28 ball bearing drawer slides
- Robust wall construction
- Double powder coating
- Full drawer extension capabilities

\$449

SP40101

7 DRAWER ROLL CAB

680w x 460d x 940h (mm)

- Internal locking system for extra security
- Heavy duty 28 ball bearing drawer slides
- Robust wall construction
- Double powder coating
- Full drawer extension capabilities
- Heavy duty castors - 2x lockable swivel

\$795

SP40104



SUMO SERIES ROLLER CABINET WITH POWER TOOL CUPBOARD AND BUILT-IN POWER BOARD

12 DRAWER

1434w x 560d x 1090h (mm)

Built-in power board with 4 individually switched power outlets and 4 USB ports, adjustable shelf and deep drawer

- Stainless steel work top
- Heavy duty 28 ball bearing drawer slides
- Internal locking system
- SP Kliklok drawer locking system ensures drawers stay closed and secure
- Heavy duty wheels
- Double powder coating resists scratching



\$2695

\$270 SP40095



HOT DEAL



STAINLESS STEEL WORKTOP

FULL LENGTH DEEP TO DRAWER

POWER TOOL CUPBOARD

BUILT-IN POWER BOARD

SP CLIKLOK DRAWER LOCKING SYSTEM

BENCHES & TROLLEYS



\$995

SP40400

HEAVY DUTY WORKSHOP BENCH

- Heavy duty steel frame
- 3x lockable drawers
- 53 Litre storage capacity
- Can be bolted to the floor



2000w x 645d x 872h
STAINLESS STEEL & RUBBER WORKTOP



PROFESSIONAL ENGINE TEAR DOWN BENCH

1200w x 645d x 872h (mm)

- Heavy duty steel frame
- Tapered bench top to drain oil/ fluid away from work area
- Load capacity: 260kg
- 1 lockable drawer
- Fluid receiver: 5 Litre
- Supplied with heavy duty castors or can be bolted to the floor

\$749

SP40415

ORGANISERS

IDEAL FOR TOOL KIT ORGANISATION

SPANNER RACKS

HOLDS UP TO 15 SPANNERS

- Versatile spanner organiser, designed to neatly store open end, ring or combination spanners.
- Built in eyelet mounting holes ideal for wall mounting, peg boards, shadow boards or tool cabinets
- Fuel and solvent resistant

SP31717 REVERSE
SP31716 FORWARD

\$19.95

EACH



NEW

STUBBY SPANNER RACK

HOLDS UP TO 12 SPANNERS

- Designed to neatly store stubby open end, ring or combination spanners.

\$19.95

SP31720

PLIER RACK

HOLDS UP TO 12 PLIERS

- Versatile organiser
- Manufactured from high impact plastic
- Adjustable dividers

\$35

SP31710

NEW

SOCKET RAILS

- Twist Lock sockets onto rail by turning them to the right - Unlocked by turning to the left

NEW

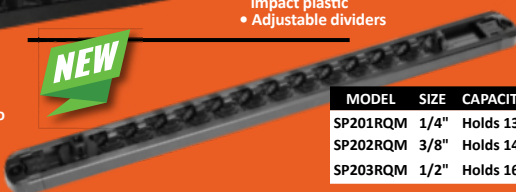

MODEL	SIZE	CAPACITY	PRICE
SP201RQM	1/4"	Holds 13pc	\$49
SP202RQM	3/8"	Holds 14pc	\$55
SP203RQM	1/2"	Holds 16pc	\$59

DIAGNOSTIC TROLLEY 4 DRAWER

964w x 414d x 964h (mm)

- Internal locking system for extra security
- Heavy duty 28 ball bearing drawer slides
- Robust wall construction
- Double powder coating resists scratching
- Full drawer extension capabilities
- 4x swivel (2x lockable) heavy duty castors

WORK SURFACE WITH STORAGE COMPARTMENT UNDERNEATH

\$495

SP40015



TOOL TROLLEY 2 DRAWER

900w x 490d x 890h (mm)

- Screwdriver slots on both sides of trolley
- 2x Swivel lockable heavy duty castors
- 2x Fixed heavy duty castors

\$495

SP40107



SOCKETS

MULTIDRIVE

1/4", 3/8" & 1/2" DR SOCKET SET METRIC/SAE 59 PIECE

**HOT
DEAL**



SET INCLUDES

- 1/4": 4 to 22mm • 1/4 to 1/2"
- 3/8": 13 to 19mm • 9/16 to 3/4"
- 1/2": 21, 22, 24, 27, 30 & 32mm • 13/16 - 1-1/4"
- Spark Plug Sockets • Inhex • 45T Ratchets
- Flex Handle • Extension Bars

12
PT

\$295

SP20280



12
PT

22PC 3/8" DR METRIC/SAE SOCKET SET

\$125

SP20220

LOW PROFILE
DESIGN

- METRIC - 8 to 19mm
- SAE - 1/4 to 3/4"
- Low Profile Ratchet



\$95

EACH

23PC 1/4" DR METRIC/SAE SOCKET SETS

6PT METRIC/SAE

- METRIC: 4 to 13mm
- SAE: 3/16 to 1/2"
- 45T Ratchet • Flex Handle
- Extension Bar

SP20102

6
PT

12PT METRIC/SAE

- METRIC: 4 to 13mm
- SAE: 3/16 to 1/2"
- 45T Ratchet • Flex Handle
- Extension Bar

SP20100

12
PT



\$139

EACH

32PC 3/8" DR METRIC/SAE SOCKET SETS

6PT METRIC/SAE

- METRIC: 6 to 22mm
- SAE: 1/4 to 7/8"
- 45T Ratchet • Flex Handle
- Spark Plug Sockets

SP20202

6
PT

12PT METRIC/SAE

- METRIC: 6 to 22mm
- SAE: 1/4 to 7/8"
- 45T Ratchet • Flex Handle
- Spark Plug Sockets

SP20200

12
PT



888 SERIES 55PC 1/4" & 3/8" DR
METRIC/SAE SOCKET SET

- METRIC: 1/4" Dr: 6 - 12mm | 3/8" Dr: 8 - 19mm
- SAE: 1/4" Dr: 7/32 - 1/2" | 3/8" Dr: 3/8 - 3/4"
- + ACCESSORIES

\$129

T820199



888 SERIES 39PC 1/2" DR
METRIC/SAE SOCKET SET

- METRIC: 8 - 32mm • SAE: 3/8 - 1-1/4"
- + RATCHETS, FLEX HANDLES, EXTENSION BARS,
SPARK PLUG SOCKETS, UNIVERSAL JOINTS

\$189

T820300



888 SERIES 27PC 3/4" DR
METRIC/SAE SOCKET SET

- METRIC: 22, 24, 27, 30, 32, 36, 38, 41, 46 & 50mm
- SAE: 7/8, 15/16, 1, 1-1/8, 1-3/16, 1-5/16, 1-3/8,
1-7/16, 1-5/8, 1-3/4, 1-7/8 & 2"

JUMBO SIZES
UP TO 50mm & 2"

\$295

T820400

SOCKET ACCESSORIES

FLEX HANDLES

AVAILABLE IN
1/4", 3/8" & 1/2" DR

- Hinged joint head
- One piece steel
- Chrome Vanadium Steel (Cr-V) for high durability

MODEL DRIVE LENGTH PRICE

SP21311	1/4" Dr	140mm	\$32
SP22311	3/8" Dr	200mm	\$39
SP23398	1/2" Dr	380mm	\$69

3/8" DR EXTRA LONG SPARK PLUG SOCKETS

MAGNETIC

- Extra long shaft - 250mm
- Built-in strong magnetic insert ensures the spark plug stays in the socket

250mm

MODEL SIZE PRICE

SP22487	14mm	\$25
SP22488	16mm	\$33

3PC WOBBLE EXTENSION BAR SETS

SETS AVAILABLE IN
1/4", 3/8" & 1/2" DR

- Access hard to reach nuts and bolts in engine bays

MODEL SIZE PRICE

SP21330	1/4" Dr	\$39
SP22330	3/8" Dr	\$55
SP23330	1/2" Dr	\$99

UNIVERSAL JOINTS

AVAILABLE IN
1/4", 3/8", 1/2" & 3/4" DR

- Flexible Joint - Ideal for accessing hard to reach nuts and bolts
- Chrome Vanadium Steel (Cr-V) for high durability

MODEL DRIVE PRICE

SP21320	1/4"	\$17
SP22320	3/8"	\$19
SP23320	1/2"	\$25
SP24320	3/4"	\$95

IMPACT SOCKETS

1/2"DR DEEP INHEX IMPACT SOCKET SETS

FROM
\$145



MODEL	TYPE	INCLUDES	PRICE
SP20310	15pc METRIC	• 10 to 19, 21, 22 & 24mm	\$145
SP20315	14pc SAE	• 3/8 to 1"	\$145
SP20380	9pc TORX	• T20 to T70	\$149

6 PT

12PC 3/8"DR IMPACT TWIST SOCKET SET

- Metric: 8, 10 to 19mm
- Pin punch for bolt removal
- Twisted teeth dig in to rounded bolts/lug nuts to provide extreme grip for easy removal.

\$169

SP31260



1/2"DR DEEP INHEX IMPACT SOCKET SETS

9PC METRIC
• 4, 5, 6, 7, 8, 10, 12, 14 & 17mm

SP20370

9PC SAE
• 3/8 to 15/16 & 1"

SP20375

\$149

EACH



1"DR IMPACT SOCKET SETS

9PC METRIC
27, 30, 32, 34, 36, 38, 41, 46 & 50mm

SP20510

6 PT

9PC SAE

- 1, 1-1/8, 1-1/4, 1-3/8, 1-1/2, 1-5/8, 1-3/4, 1-7/8 & 2"

SP20515



\$375

EACH

3/4"DR IMPACT SOCKET SETS

8PC METRIC
• 24, 27, 30, 32, 34, 36, 41 & 46mm

SP20410

6 PT

8PC SAE

- 1, 1-1/16, 1-1/8, 1-1/4, 1-5/16, 1-3/8, 1-7/16 & 1-1/2"

SP20415



\$229

EACH

3/4"DR DEEP IMPACT SOCKET SETS

8PC METRIC
• 24, 27, 30, 32, 34, 36, 41 & 46mm

SP20420

6 PT

8PC SAE

- 1, 1-1/16, 1-1/8, 1-1/4, 1-5/16, 1-3/8, 1-7/16 & 1-1/2"

SP20425



\$299

EACH

IMPACT SOCKET RAILS



3/8"DR STUBBY IMPACT SOCKET RAIL SET

10pc METRIC
• 10, 11, 12, 13, 14, 15, 16, 17, 18 & 19mm

\$69

6 PT

SP20255



1/2"DR IMPACT SOCKET RAIL SETS

11pc METRIC
• 10 to 24mm

\$99

9pc SAE
• 3/8 to 1"

\$99

6 PT

SP20350

SP20351



1/2"DR WHEEL NUT IMPACT SOCKET RAIL SET

5pc METRIC
• 15, 17, 19, 21 & 22mm

\$69

6 PT

SP20390



3/8"DR DEEP IMPACT SOCKET RAIL SET

10pc METRIC
• 10, 11, 12, 13, 14, 15, 16, 17, 18 & 19mm

\$109

6 PT

SP20260



1/2"DR SWIVEL IMPACT SOCKET RAIL SETS

13pc METRIC
• 10 to 24mm

\$199

9pc SAE
• 3/8 to 7/8"

\$149

6 PT

SP20356

SP20366

3PC 3/4" DR DOUBLE SQUARE IMPACT SOCKET SET

- 17, 19 and 21mm

\$89

SP20470



IMPACT ADAPTORS

MULTIPLE DRIVES AVAILABLE
3/8", 1/2", 3/4" 1" & 1-1/2"DR

MODEL	DRIVE	PRICE	MODEL	DRIVE	PRICE
SP22356	3/8" F x 1/2" M	\$9.95	SP25355	1" F x 3/4" M	\$49
SP23355	1/2" F x 3/8" M	\$13.00	SP25357	1" F x 1-1/2" M	\$69
SP23356	1/2" F x 3/4" M	\$19.95	SP26355	1-1/2" F x 1" M	\$149
SP24355	3/4" F x 1/2" M	\$25.00	SP26356	1-1/2" F x 2-1/2" M	\$209
SP24356	3/4" F x 1" M	\$32.00			



IMPACT UNIVERSAL JOINTS

MODEL	DRIVE	PRICE
SP22350	3/8"	\$19
SP23350	1/2"	\$22
SP24350	3/4"	\$59
SP25350	1"	\$99
SP26350	1-1/2"	\$340

- Flexible Joint - Ideal for accessing hard to reach nuts and bolts
- Cr-Mo for high durability



SPANNERS

HOT DEAL

SP HAS A FULL RANGE OF SPANNER SETS TO SUIT ANY APPLICATION

- Small head profile designed for working in confined spaces.
- Tough triple chrome, high polish finish.
- Chrome Vanadium Steel (Cr-V) for high durability.
- Meets & exceeds international ANSI & DIN standard.



METRIC COMBINATION ROE QUAD DRIVE SPANNER SET 14 PIECE

SIZES INCLUDED
• 6 to 19mm



\$99

SP10014



HOT COMBO DEAL

888 SERIES ROE COMBO SPANNER SETS

INCLUDES METRIC & SAE SETS

16pc METRIC • 6 to 24mm
11pc SAE • 1/4 to 7/8"

15° OFFSET

T810016B

\$139



QUAD DRIVE ROE COMBINATION SPANNER SETS

METRIC & SAE SET AVAILABLE

11pc METRIC • 8 to 22mm
SP10011

\$129

11pc SAE • 1/4 to 7/8"
SP10061

\$129



COMBINATION ROE RING END SPANNER SETS

JUMBO SIZES 15° OFFSET

3pc METRIC
• 41, 46 & 50mm
SP10020

\$399

4pc SAE
• 1-5/8, 1-3/4, 1-7/8 & 2"
SP10070

\$485

DOUBLE RING LONG SPANNER SETS

METRIC & SAE SET AVAILABLE

6pc METRIC
• 8 to 19mm
SP10136

\$99

5pc SAE
• 5/16 to 15/16"
SP10185

\$99

40° OFFSET

FLARE NUT SPANNER SETS

METRIC & SAE SET AVAILABLE

4pc METRIC
• 10 to 22mm
SP10044

\$85

4pc SAE
• 3/8 to 7/8"
SP10094

\$85

FLEX HEAD FLARE NUT SPANNER SETS

METRIC & SAE SET AVAILABLE

4pc METRIC
• 10 to 22mm
SP10144

\$189

4pc SAE
• 3/8 to 7/8"
SP10194

\$189

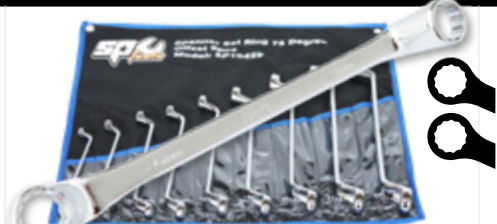

DOUBLE RING LONG SPANNER SET

9pc METRIC
• 8 to 26mm
SP10429

\$199

75° OFFSET



16PC 3/8" DR E-TORX SOCKET & SPANNER SET

3/8" Dr E-TORX SOCKETS - 12 PIECE
• E4 to E12, E14, E16, E18, E20
3/8" Dr E-TORX SPANNERS - 4 PIECE
• E6xE8, E10xE12, E14xE16, E18xE20

\$129

SP20210

EVA FOAM TRAY SPANNER SET

25PC METRIC & SAE
• 6 to 19mm
• 1/4" to 7/8"
SP50015

\$299



FLAT DRIVE TECHNOLOGY

Perfectly flat spanner head surfaces allow for maximum contact between the spanner and the bolt or nut, maximising grip and enhancing applied torque.



SP FLAT DRIVE SPANNER HEAD



REGULAR CONTACT AREA

MAXIMUM CONTACT

Spanner heads make contact on the flat sides of the fastener head, not the points.



QUAD DRIVE OPEN END

SP Tools patented **QUAD DRIVE** open end offers 4 times the gripping power of a standard ROE spanner by wrapping around the fastener and maximising the contact on the flat sides of the fastener head, not the points.

PATENTED



HOT DEAL



JUMBO 15° OFFSET
METRIC COMBINATION ROE QUAD DRIVE SPANNER SET 9 PIECE
 SIZES INCLUDED
 • METRIC: 19 to 36mm

\$425
SP10019



15° OFFSET
QUAD DRIVE ROE COMBINATION SPANNER SET
INCLUDES METRIC & SAE SIZES
 18pc METRIC & SAE
 • 8 to 19mm • 3/8" to 7/8"
\$249
SP10001



15° OFFSET
GEAR DRIVE ROE COMBINATION SPANNER SETS
METRIC & SAE SET AVAILABLE
 9pc METRIC
 • 10 to 19mm
T810109 \$122
 7pc SAE
 • 3/8 to 3/4"
T810157 \$105



JUMBO 15° OFFSET
COMBINATION ROE RING END SPANNER SETS
METRIC & SAE SET AVAILABLE
 10pc METRIC
 • 24 to 50mm
T810020 \$349
 10pc SAE
 • 15/16 to 2"
T810070 \$349



REVERSIBLE
FLEX HEAD GEAR DRIVE ROE QUAD DRIVE
METRIC & SAE SET AVAILABLE
 11pc METRIC
 • 8 to 19mm
SP10311 \$355
 8pc SAE
 • 5/16 to 3/4"
SP10358 \$235

PREMIUM SHIFTERS



3PC ADJUSTABLE WRENCH SET 888 SERIES
\$55
T818000

CONTENTS:
 • 150mm (6")
 • 200mm (8")
 • 250mm (10")

FEATURES:
 • Slimline for tight areas
 • Laser etched width gauges
 • Precision ground jaws
 • Excellent Leverage



ADJUSTABLE WRENCH WIDE JAW - PREMIUM BLACK OXIDE

- 18-25% wider opening
- Greater working angle
- Thicker heavy duty handle
- Higher torque capabilities

FROM \$30

MODEL	DRIVE	PRICE
SP18053	100mm	\$30
SP18058	150mm	\$35
SP18063	200mm	\$37
SP18068	250mm	\$49
SP18073	300mm	\$59
SP18078	375mm	\$105
SP18083	450mm	\$169
SP18088	600mm	\$259

SLOGGING SPANNERS



- Slugging /Slogging /Striking Spanners designed for use with a sledgehammer or pneumatic hammers for heavy mechanical applications.
- Short profiled handle with heavy duty striking end
- Spanners are drop forged from industrial quality steel to withstand heavy impact

MODEL	SIZE	PRICE
SP19430	30mm	\$29
SP19432	32mm	\$31
SP19434	34mm	\$34
SP19436	36mm	\$38
SP19438	38mm	\$41
SP19441	41mm	\$43
SP19446	46mm	\$59
SP19455	55mm	\$75
SP19460	60mm	\$85
SP19465	65mm	\$109
SP19475	75mm	\$145
SP19480	80mm	\$173
SP19485	85mm	\$215
SP19490	90mm	\$250
SP19495	95mm	\$269
SP19500	100mm	\$289



3/8"DR FLEX CROWFOOT NUT SOCKET RAIL SETS **METRIC & SAE SET AVAILABLE**

10PC METRIC
 • 10 to 19mm
SP20574 \$105

7PC SAE
 • 3/8 to 3/4"
SP20594 \$95



DUAL FLAT DRIVE RING END
 SP Tools **RING END** spanners feature dual flat drive ring ends, making them the perfect spanner for getting to and loosening those tricky, hard to reach, often worn fasteners by increasing the contact area with the nut or bolt head.



GEAR DRIVE RING END
 SP Tools patented **GEAR DRIVE** spanners are precisely machined with deeper gears for greater torque loading and reliability with 72 teeth that only require 5° of space per turn.



HAND TOOLS

BIT SETS & SCREWDRIVERS

60PC PROFESSIONAL BIT SET

- Diverse range of bit types and lengths
- Bit set neatly organised in sturdy case
- Spring loaded ball bearings hold bits firmly in place

SET INCLUDES:
10mm Dr Inhex Shank 30mm(L) Bits
• Inhex, Spline & Torx

10mm Dr Inhex Shank 75mm(L) Bits
• Inhex, Spline, Torx & Ribe

Adapters
• 10mm Inhex Bit Adapters
• 1/2" Dr x 14mm Inhex Bit Adapter
• Inhex Buffer Adapter



\$163
SP39620

12PC SCREWDRIVER SET

- Organised set of professional quality screwdrivers designed to fit into your tool box
- SVCM steel shafts for strength and durability
- Magnetic tips
- Includes stubby sizes

CONTENTS
• 6 x Slotted - 2.5 x 75, 5.5 x 75, 6.0 x 25, 6.0 x 100, 8.0 x 150 & 8.0 x 300mm
• 6 x Phillips - #0 x 75, #1 x 75, #2 x 25, #2 x 100, #2 x 300 & #3 x 150mm

HOUSED IN EVA FOAM



\$139
SP34003G

8PC GO-THRU SCREWDRIVER SET IN X-CASE

- 4 x Slotted • 4 x Phillips

- Go-thru with steel strike cap for use with a hammer to loosen stubborn screws
- Hex shafts and hex bolster collars

\$99
SP34020



8PC TORX SCREWDRIVER SET IN X-CASE

- T8, T10, T15, T20, T25, T27, T30 & T40

- Essential in the removal of Torx Tamper proof safety screws
- Chrome Vanadium Steel (SVCM) shafts

\$90
SP34050



8PC INSULATED SCREWDRIVER SET IN X-CASE

- 4 x Slotted • 4 x Phillips

- VDE - Insulated handle & blades
- Safe for applications up to 1000 V AC / 1500V DC

\$90
SP34042



HEX & TORX KEYS

MAGNETIC FOLDING KEY COMBO PACK

INCLUDES METRIC, SAE & TORX SETS

9PC METRIC

- 1.5, 2, 2.5, 3, 3.5, 4, 4.5, 5 & 6mm

8PC SAE

- 1/16", 5/64", 3/32", 1/8", 9/64", 5/32", 3/16" & 1/4"

7PC TORX

- T10, T15, T20, T25, T27, T30 & T40

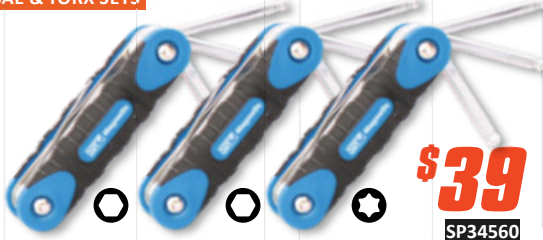

\$39
SP34560



BALL DRIVE ON METRIC & SAE SETS

T-HANDLE HEX KEY SET

8PC METRIC

- 2, 2.5, 3, 4, 5, 6, 8 & 10mm

- Chrome Vanadium Steel (Cr-V) blade
- Hardened and tempered
- Easy grip comfort handle
- Double ended

\$69
SP34705



9PC KEY SETS - STUBBY SERIES

AVAILABLE IN METRIC, SAE & TORX

COLOUR CODED

METRIC SP34531

- 1.5, 2, 2.5, 3, 4, 5, 6, 8 & 10mm

SAE SP34532

- 1/16, 5/64, 3/32, 1/8, 5/32, 3/16, 1/4, 5/16 & 3/8"

TORX SP34537

- T10, T15, T20, T25, T27, T30, T40, T45 & T50

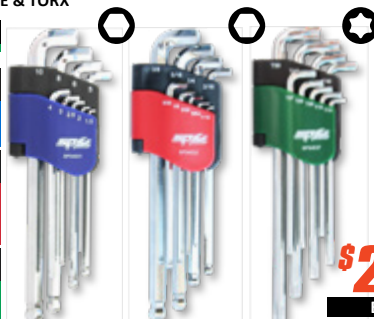

\$29
EACH

BALL DRIVE ON METRIC & SAE SETS

9PC KEY SETS - LONG SERIES

METRIC T834511

- 1.5, 2, 2.5, 3, 4, 5, 6, 8 & 10mm

SAE T834512

- 1/16, 5/64, 3/32, 1/8, 5/32, 3/16, 1/4, 5/16 & 3/8"

TORX T834517

- T10, T15, T20, T25, T27, T30, T40, T45 & T50

TAMPER TORX T834518

- T10, T15, T20, T25, T27, T30, T40, T45 & T50



\$29.95
EACH

COLOUR CODED

BALL DRIVE ON METRIC & SAE SETS



PLIERS

MULTIGRIPS SET HIGH LEVERAGE 3 PIECE

- Forged Chrome Molybdenum(Cr-Mo) Steel
- High leverage allows for effortless extended use
- Multiple jaw position for heavier and varied gripping applications

INCLUDES
• 165mm (6")
• 240mm (9")
• 320mm (12")

\$99

LOCK BARS
Finger guard lock bar ensures you don't get your fingers caught



3PC LONG HANDLE PLIER/CUTTER SET

- Long reach 275mm long pliers - ideal for reaching where standard pliers will not
- Serrated jaws ensure a secure grip in any conditions
- Slip resistant cushion grips
- Chrome Vanadium Steel (Cr-V) for high durability

\$100

3PC PLIER/CUTTER SET

**VDE INSULATED
1000V VDE**



- Forged chrome Vanadium (Cr-V) Steel blades for increased strength and durability
- Induction hardened cutting edges
- Insulated grip handles: 1000V VDE
- Slip guard handles for added safety



\$79

4PC MINI PLIER/CUTTER SET

- Precision induction hardened cutting edges
- Non-slip cushion comfort grips
- Spring handle allows for reduced and fatigue easy operation

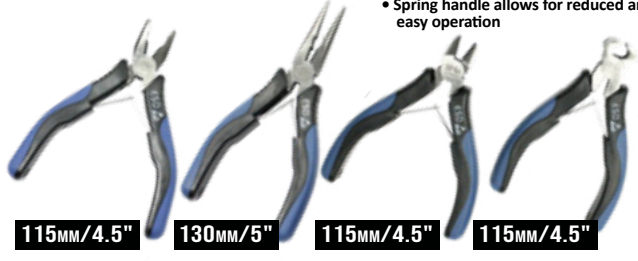

\$85

4PC CIRCLIP PLIER SETS

- Suitable for installing and removing external and internal retaining clips
- Slim jaws for optimum access
- Chrome Vanadium Steel (Cr-V) for high durability
- Spring loaded ergonomic handles with non-slip cushion grips

AVAILABLE IN 3 SIZE SETS

MODEL	SIZE	PRICE
SP32931	140mm (5.5")	\$85
SP32932	175mm (7")	\$89
SP32933	240mm (9.5")	\$99



10PC 888 SERIES LOCKING PLIER SET

AVAILABLE MAY

- SET INCLUDES
- 4x C-Type Locking Pliers
 - 2x Long Nose Locking Pliers
 - 2x Curved Jaw Locking Pliers
 - 2x Sheet Metal Locking Pliers

\$99

T832929



NORMALLY ~~\$154~~

- Heavy duty hardened jaws for increased gripping power
- Ergonomical non-slip rubber handles
- Heavy duty knurled adjuster nut
- Easy quick-release lever
- Includes heavy duty canvas pouch with hanging hooks



SNIPS

**HOT
DEAL**

INDUSTRIAL SHEARS/SCISSORS

180MM (7")

\$15

EACH

- Industrial duty stainless steel, non-slip serrated edge blades for increased cutting capacity
- Ideal for multiple applications, from thin wire to Kevlar®
- Spring-loaded action provides responsive snipping action
- Ergonomical non-slip grip handles
- Steel locking latch keeps shears safe and secure



AVAILABLE IN 2 OPTIONS

MODEL	BLADE TYPE
SP32267	Rounded Tip
SP32266	Safety Tip

LOCKING PLIERS

CURVED JAW SET - 3PC 888 SERIES

- Non-slip curved jaws maximises pressure points for any bolt, nut or locking tool application
- Heavy duty hardened jaws for increased gripping power
- Knurled adjuster nuts
- Easy quick-release levers

- INCLUDES
- 150mm (6")
 - 200mm (8")
 - 250mm (10")



\$39

T832921

SHEET METAL 200MM (8")

- Wide jaws for extra grip
- Heavy duty knurled adjuster nut
- Easy quick-release lever



\$30

SP32640

WELDING CLAMP 230MM (9")

- Heavy duty non-slip jaws
- Heavy duty knurled adjuster nut
- Easy quick-release lever



\$25

SP32645



FACEBOOK
sphandtools



INSTAGRAM
@sptools



YOUTUBE
sptools

HAND TOOLS

CONTINUED

CHISELS

PUNCH & CHISEL SET 10 PIECE

SET INCLUDES
• Pin punches: 2, 3, 4, 5, 6, 8 & 10mm
• Cold chisels: 12, 20 & 24mm



\$99

SP30841

HOLLOW PUNCH SET 9 PIECE

SET INCLUDES
• 2.5, 3, 4, 5, 6, 7, 8, 9 & 10 mm



\$19.95

SP30950

CUTTING TOOLS

DRILL BIT SETS HIGH SPEED STEEL

- Made from high quality high speed steel (HSS)
- Industrial grade - extremely sharp, strong and durable
- Drills perfectly round holes in steel, brass, plastic, wood etc.

25PC

• 1-13mm (0.5 increments)

\$139

SP31391



5 PIECE TUNGSTEN CARBIDE BURR SETS

- Extremely durable
- Heavy duty, superior cutting power
- Ideal for deburring, carving, grooving, shaping, finishing and filing

\$129

EACH

- INCLUDES
- 10 x 20mm - Cylinder
 - 10 x 20mm - Cylinder - Radius Top
 - 8mm Dia. - Ball
 - 10 x 25mm - Tree - Radius Top
 - 12 x 20mm - Oval

MODEL APPLICATION

SP31380 Steel
SP31385 Aluminium



FILE SET - 254MM (10") 5 PIECE

- Ideal for sharpening, shaping and de-burring metals and polymers

\$75

SP36035



UTILITY KNIFE FOLDING LOCK-BACK

- Lightweight & durable
- Quick blade change
- Fixed blade for more powerful cutting



- On-board spare blade storage (Includes 5 spare blades)

\$19

SP30850

RIVETERS & NUTSERTS

HAND RIVETER 2 JAW

- Suits all materials - aluminium, steel & stainless steel
- Comes with 4 nozzle tips



\$29

SP69020

SETS RIVET SIZES

- Metric: 2.4, 3.2, 4.0 & 4.8mm
- SAE: 3/32", 1/8", 5/32" & 3/16"

NUTSERT GUN LEVER TYPE

- Easy change mandrels
- Single or two hand operation
- 250mm long



\$59

SP69010

- Sets 3, 4, 5 & 6mm rivet nuts
- Light weight cast aluminium construction

HAMMERS

SLEDGE HAMMERS

FIBREGLASS HANDLE

- Multi-purpose & heavy duty
- Heat treated head with overstrike protector
- Durable nanofiber handle for unrivalled strength and shock reduction
- Non-slip rubber grip



MODEL	SIZE	PRICE
SP30372	3.6kg / 128oz / 8lbs	\$49
SP30374	4.5kg / 160oz / 10lbs	\$59
SP30376	5.4kg / 192oz / 12lbs	\$79

BALL PEIN HAMMERS

ONE PIECE - ANTIVIBRATION

- One-piece hardened and tempered carbon steel hammer for extreme strength and durability
- One piece antivibration head and shaft design
- Non-slip rubber grip

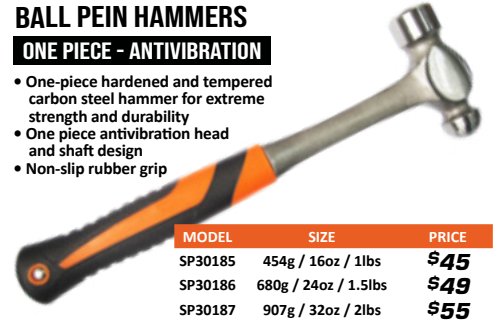

MODEL	SIZE	PRICE
SP30185	454g / 16oz / 1lbs	\$45
SP30186	680g / 24oz / 1.5lbs	\$49
SP30187	907g / 32oz / 2lbs	\$55

CLUB HAMMERS

ONE PIECE - ANTIVIBRATION

- Multi-purpose & heavy duty
- Dual striking faces
- One-piece hardened and tempered carbon steel hammer
- One piece antivibration head and shaft design



MODEL	SIZE	PRICE
SP30333	907g / 32oz / 2lbs	\$29
SP30349	1360g / 48oz / 3lbs	\$39
SP30365	1814g / 64oz / 4lbs	\$49

BALL PEIN HAMMER

TOM THUMB

- Ideal for applications where space is limited
- Durable nanofiber handle for shock reduction



• 227g / 8oz / .5lbs **SP30189**

CLAW HAMMER

FIBREGLASS HANDLE

- 888 Series
- Drop forged carbon steel
- Reinforced fibreglass Handle
- Ergonomically designed for comfort & safety



567g / 20oz / 1.25lbs **T830190**



SP TOOLS HAS TRADIES COVERED

SIMPLY PURCHASE A 'TRADIE CASH' MARKED PRODUCT AND RECEIVE AN ONLINE VOUCHER TO SPEND AT WWW.SPTOOLS.COM
Visit sptools.com for full terms & conditions.

REDEEMING IS QUICK AND EASY.

VISIT OUR APPRENTICE PAGE AT WWW.SPTOOLS.COM FOR MORE INFORMATION

WIRELESS CHARGE

WIRELESS CHARGE SMD LED WORK LIGHT & TORCH TWIN PACK

WORKLIGHT/TORCH

- SMD LED Worklight: 500 Lumen
- LED Torch: 150 Lumen
- Adjustable Dimmer Worklight: 500 to 75 Lumens
- Flexible Magnetic Base
- 180° Fold Out Hook

CHARGING PAD
ALSO WIRELESSLY CHARGES
ALL Qi ENABLED DEVICES

\$279
SP81499

COMPACT WORKLIGHT/TORCH

- SMD LED Worklight: 300 Lumen
- LED Torch: 100 Lumen
- Adjustable Dimmer Worklight: 300 to 30 Lumens
- Flexible Magnetic Base
- 180° Fold Out Hook

LUMENS 500 WORKLIGHT
LUMENS 150 TORCH

DUAL ZONE CHARGING PAD

- Dual charging zones
- Magnetic zones holds lights firmly in place while charging

LUMENS 300 WORKLIGHT
LUMENS 100 TORCH

WIRELESS CHARGE WORKLIGHT & TORCH

- Adjustable Dimmer Worklight
- Flexible Magnetic Base
- 180° Fold Out Hook
- Magnetic zone holds light firmly in place while charging

NORMALLY **\$196**
\$139
SP81496

LUMENS 500 WORKLIGHT
LUMENS 150 TORCH

CHECK OUT THE DEMO VIDEO

SCAN ME



TORCH/WORK LIGHT LED PEN MAGBASE

- Compact lightweight design
- Strong magnetic clip
- Rechargeable Lithium Ion
- Overall Length: 80mm
- Width: 20mm

LUMENS 130 WORKLIGHT
LUMENS 50 TORCH
\$19
SP81439

FLASHLIGHT - LED ADJUSTABLE BEAM RECHARGEABLE

- Heavy duty compact design
- Ideal for camping and outdoor activities
- Essential in emergency situations
- Tactical head for breaking glass
- Adjustable focal length
- Recharges using a vehicles on board 12v outlet

LUMENS 130 WORKLIGHT
12v CHARGE
\$19
SP81490

TORCH/WORK LIGHT SMD LED MAGBASE

- Super bright SMD LED work light
- High power LED torch/top light
- Rechargeable Lithium-ion

\$99
SP81456
LUMENS 350 WORKLIGHT
LUMENS 100 TORCH

SLIMLINE COB LED WORK LIGHT & TORCH

- Dimmable Worklight
- Adjustable dimmer switch work light
- 120° Pivoting slimline head
- 360° fold out hook
- Strong magnetic base
- Rechargeable

\$99
SP81446
LUMENS 1000 WORKLIGHT
LUMENS 150 TORCH

COB LED HEAD LAMP

45° TILT

NORMALLY **\$112**

\$79
SP81492

SMART ON/OFF MOTION SENSOR

Ideal for mechanics whose hands are usually greasy/oily

- Ultra bright
- 45° Flexible light positioning

LUMENS 300 WORKLIGHT
LUMENS 150 WORKLIGHT

COB LED WORK LIGHT

COMPACT SWIVEL

- 3 Settings
- Rechargeable
- Strong Magnetic Base
- 360° Swivel Joint
- Run time: 13/4/2 Hours (Low/Med/High)

\$89
SP81448
LUMENS 700 WORKLIGHT
LUMENS 350 WORKLIGHT
LUMENS 100 WORKLIGHT

PREMIUM UNDER BONNET CORDLESS LED WORKLIGHT

- High power SMD LED work light
- Low power consumption with low heat emission
- Extendable for applications between 1150 and 1800mm
- Brightness control - 2 settings
- 360° Swivel light for flexible light positioning
- Diffused lens for softer lighting and reduced shadow
- Wide 120° light spread

\$269
SP81466

EXTENDABLE

Easily adjusts to suit bonnet sizes up to 1800mm

360° SWIVEL



MULTIPURPOSE

BLUETOOTH SPEAKER. WORK LIGHT. POWER BANK.

SPEAKER FUNCTION

- Connects to your smart device via long range bluetooth 5.0, allowing you to play all your favourite jams on the go, in the workshop, at home, in the gym or out camping.
- Smart Dual Link Technology allows you to connect two of these units together for a louder, fuller surround sound experience.
- Control playback through your phone or through the user friendly interface on the unit.

WORK LIGHT

Strong magnetic base and side panel allows you to fix this unit to any magnetic surface and use as a high powered work light.

POWER BANK

Conveniently charge your smart devices using the built-in 2.0 USB port

DUAL LINK

SYNC 2 DEVICES TOGETHER FOR SURROUND SOUND

\$169
SP81400

CHECK OUT THE DEMO VIDEO

SCAN ME



HOT DEAL

LUMENS 800 WORKLIGHT
LUMENS 400 WORKLIGHT



ELECTRICAL & DIAGNOSTIC

CAN OBDII/EOBD/JOBD SCANNER CODE READER

READS & CLEARS GENERIC & MANUFACTURER SPECIFIC DIAGNOSTIC TROUBLE CODES (DTC'S) & TURNS OFF CHECK ENGINE LIGHT.

- Covers all OBDII compliant vehicles: Made in USA from 1996 on; Made in Europe petrol 2001 on & diesel 2004 on; Made in Australia or New Zealand from 2006 on. (Including the CAN, J1850 PWM, J1850 VPW, ISO9141 and KWP2000 protocols)
- Compliant with OBDII 16 PIN Toyota, Honda, Daihatsu, Mitsubishi, Mazda, Nissan, Suzuki & Subaru
- Wider vehicle coverage with CAN protocol support
- Supports multiple trouble code requests: Generic codes, pending codes and manufacturer specific codes
- Code definitions are displayed on unit screen
- Reviews the emission readiness status of OBDII Monitors



WATCH THE DEMO VIDEO

SCAN ME

MAKE SURE YOUR VEHICLE IS CAN OBDII/EOBD/JOBD COMPLIANT BEFORE PURCHASING



\$225

SP61155

HOT DEAL

MINI INFRARED THERMOMETER

- LCD Display with Backlight
- Single Dot Laser Targeting
- Low battery Indication
- Auto Power Off
- -20°C / 270°C Range (-4 °F - 518°F)



\$99

SP62022

BATTERY ANALYSER



\$129

SP61060

- Suitable to test all 12V automotive starting batteries, including ordinary lead acid battery, AGM flat plate battery, AGM spiral battery, and Gel batteries

SELF-IGNITING PROFESSIONAL GAS SOLDERING/TORCH KIT

+ HEAT SHRINK FUNCTION

- Professional self-igniting cordless butane gas soldering iron with interchangeable tips
- Ideal for various applications in automotive repairs, electrical/electronic circuit repair, light gauge welding, brazing and jewellery industries.
- Fast heat-up for increased productivity with a 70 minute continuous use run time
- Can be used as a blow torch



\$99

SP32290

KIT INCLUDES:

- Refillable butane gas soldering iron
- Lead free soldering wire in dispenser
- Cleaning sponge
- Heat insulated protective head cap
- Deflector attachment
- Standard Tip
- Anvil Tip
- Chisel Tip
- Knife Tip
- Needle Tip

PREMIUM BATTERY ANALYSER WITH BUILT-IN PRINTER



BUILT-IN PRINTING FUNCTIONALITY

- Auto-saving function ensures the latest test results are automatically saved for reviewing
- Tests batteries & charging/starting systems
- Easily adjustable date/time printing mode
- Extremely simple interface provides quick & easy battery analysis
- Circuit protection provides the analyser with reliable protection against short circuiting
- Reverse polarity connection protection ensures reverse connection will not damage the tester or affect the vehicle and battery
- Measurement Range: Cold Cranking Amps (CCA) 100-2000



\$325

SP61065

VIDEO BORESCOPE 6MM CAMERA

HIGH RESOLUTION

- 3.2" colour TFT LCD screen
- 1m long flexible, waterproof gooseneck imager head that easily performs visual inspections in hard to reach areas
- High visibility and 10° adjustable LED lighting
- Camera and video function supports audio and video recording



\$499

SP70935

MEMORY POWER SUPPLY

- Retains setting of computers, radios, clocks, etc. when battery is disconnected
- Attaches to 9 volt battery
- Plugs into cigarette lighter socket



\$25

SP61054

SPARK PLUG RAMP GAUGE

- Quick easy method to set spark plug gap
- Suits any size from 0.020 to 0.100 (0.6 - 2.4mm)



\$10

SP64041

BATTERY POST & TERMINAL CLEANER

- Easy cleaning of battery posts & terminals
- Internal & external wire brushes



\$15

SP61001

AUTOMATIC WIRE STRIPPERS

- Insulated: AWG: 10-22 (0.5-6mm²)
- Non Insulated: AWG: 12-10, 16-14, 22-18 (4-6, 1.5-2.5, 0.5-1mm²)
- 200mm (8")
- Crimper features
- Strips and cuts cable or wire 24-10 AWG (0.2 to 6.0mm)



\$33

SP32278

TACHOMETER DIGITAL

- Laser target
- LCD display with backlight
- Range: 100-30000rpm, 1.7-500rps
- Protective cover & carrying case
- Auto power off
- Accuracy: +/- 0.1%

\$189

SP62032



DIAGNOSTIC PUMP KIT 2 WAY DUAL MODE QUICK SWITCH

- High volume efficiency 2-Way pressure and vacuum test functions
- Integrated rear mount gauge - Optimum viewing angle - Maximum impact protection
- High quality silicon material hoses with quick couple hose fittings - Quick hose interchange - No leaks under vacuum or pressure

DUAL MODE PRESSURE AND VACUUM FUNCTIONS:

PRESSURE MODE:

- Monitor turbo charger boost pressure
- Test and adjust turbo charger waste gate actuators
- Test pressure operated central locking systems
- Test fuel tank vent valves
- Test one way valves
- Diagnose small engine faults

VACUUM MODE:

- Test EGR, one way & HVAC valves
- Test fuel pressure regulator
- Test map sensor
- Test thermal vacuum switches
- Test Electric vacuum switches
- Test automatic transmission modulator valve
- Test central locking systems



\$359

SP80020

QUICK CONNECT HOSES & ADAPTORS INCLUDED

HOUSED IN HEAVY DUTY STORAGE CASE



WATCH THE DEMO VIDEO

SCAN ME

DIGITAL MULTIMETER WITH TEMP GAUGE

- 2000 counts digital display
- Safety Design Cat 3 600v
- Non-contact ACV detection
- Type K temperature input
- Continuity, diode test, resistance

\$79

SP62015



LI+ POWER BANK JUMP STARTER 700A

THE PORTABLE POWER SUPPLY FOR ANY JOB. JUMP STARTS ANY CAR, TRUCK OR MOTORCYCLE. POWER OR CHARGE 12V ACCESSORIES AND ANY USB 5V ELECTRONICS.

- 12v 250 - 700AMP Jump start (Petrol engines up to 5L V8 & Diesel up to 3L) (approx. double normal laptop battery life)
- 12v Port for powering or charging 12v accessories
- 5v USB Port for charging mobile phones, tablets & cameras (approx. 4 full mobile phone charges per charge)

\$249

SP61071



KIT INCLUDES Jumper cables, USB to various electronic device input connectors, 12V10A DC adapter cable, 12v car charger, Charger & Storage case

7PC SENSOR SOCKET SET

- Socket windows allow wires on the sensors to be bypassed
- Applications include: Mitsubishi, Nissan, GM and the Volkswagen Audi Group
- For heated & non-heated lambda sensors

\$129

SP64065



3/8" DR OXYGEN SENSOR SOCKET

- 3/8" Dr x 22mm
- Common 6 point socket fits most oxygen sensors
- Applications include: Mitsubishi, Nissan, GM and the Volkswagen Audi Group
- For heated & non-heated lambda sensors

\$19.95

SP64060



CIRCUIT TESTER SHORT PROBE 6 TO 24V

- Tests 6, 12 & 24 Volt electric circuits
- Sharp, short length probe
- Handle lights up if the circuit is good
- 1.2m cord

\$35

SP61011



6-24v

CIRCUIT TESTER LONG PROBE 6 TO 24V

- Sharp, extra long, insulated probe
- Handle lights up
- 3.6m Spring relief cord
- Heavy duty insulated alligator clip

\$55

SP61014



6-24v

CIRCUIT TESTER DIGITAL DISPLAY 5 TO 28V

- Digital LCD display for accurate voltage reading
- Reads 6, 12 & 24V DC systems
- Stainless steel testing probe
- Small testing current < 10mA

\$69

SP61016



5-28v

CIRCUIT TESTERS

CIRCUIT TESTER DIGITAL DISPLAY 3 TO 32V

- Sharp, short, insulated probe
- Digital LCD display provides a fast and accurate reading
- Dual colour LED indicator

\$69

SP61017



3-32v

CIRCUIT TESTER CORDLESS 3 TO 30V

- No earth lead - Touch ground to complete circuit
- Dual colour LED indicates: Red for power, green for ground on 6V, 12V and 24V systems

\$99

SP61018



NO EARTH LEAD

3-30v

CLICK & COLLECT
buy online · pick up in-store

You can now simply purchase your SP products online at sptools.com & pick them up from your local SP Destination Store.



SHOP ONLINE OR ON YOUR SMART PHONE

ENGINE SERVICE



49PC DIESEL FUEL RETURN FLOW TEST KIT

- Measure return fuel flow on diesel vehicles up to 8 cylinders fitted with common rail injection systems
- Identifies worn, blocked or inoperative injectors quickly & easily

\$139
SP66068

DIESEL INJECTOR EXTRACTOR AND COMMON RAIL PULLER KIT 14 PIECE

\$149
SP66082

- Suitable for fast and safe removal, inspection or replacement of Bosch, Delphi, Denso and Siemens diesel injectors.
- Set includes heavy duty slide hammer, 1/2" Dr deep open profile sockets, used to dismantle injectors, plus adaptors for attaching the slide hammer securely to the body of the injector.
- Window in socket allows the wires attached to the sensors to be bypassed, eliminating wire damage



HOT DEAL



6PC NOID LIGHT KIT

- Check fuel injector signal faults fast
- Compatible with: GM PFI, FORD TBI, GEO TBI, BOSCH PFI, GM TBI, GM SCPI

\$69
SP71050



PETROL COMPRESSION TESTER

- 2.5" gauge with dual scale, 0-300psi, 0-21kg/cm2, 0-300psi
- Pressure relief valve allows repeated on-vehicle test
- Includes multiple adaptors to fit most applications

\$55
SP66023



PISTON RING COMPRESSOR

50 TO 125MM

- Compresses piston rings for easy installation
- Self locking ratchet
- Supplied with tightening arm
- Double band adjustable tensioner

\$35
SP66020



5PC MASTER CAM CLAMP KIT

- This universal kit covers most single overhead cam engines, twin cam engines and quad cam engines
- Lock camshafts to hold valve timing during belt replacement

\$159
SP70900



VACUUM/FUEL PUMP TESTER KIT

- Check for leaking or defective parts in vacuum systems & mechanical fuel pumps
- Thick rubber bump guard
- Clear and easy to read gauge design

\$69
SP66060



FLUID EXTRACTOR 1 LITRE

- Small, fast & portable fluid extractor
- Operates with an air compressor
- Extraction is achieved using deep vacuum technology
- Designed to vacuum fluids from inaccessible or confined areas
- Quick release air supply locking trigger

\$89
SP64022



VALVE SPRING COMPRESSOR

- Suitable for use on multi valve petrol & diesel engines with deep-seated valves

• 55-175mm cap. & 165mm throat depth

\$129
SP66015



VALVE LAPPERS

- Hand grind small & large flat head unslotted valves
- Comfort grip contoured hardwood handles

SET INCLUDES:

- Small cup dia. 5/8" & 13/16"
- Large cup dia. 1-1/8" & 1-3/8"

\$14
SP66115



CAMSHAFT PULLEY REMOVER/INSTALLATION KIT

- Designed to hold the camshaft pulley stationary while loosening & tightening the centre shaft bolt
- Fixed distance 54 - 120mm

\$39
SP71065



VALVE SPRING COMPRESSOR SCREW TYPE OVERHEAD

- The jaws grip the valve spring in parallel compression
- Suits cars and light trucks

\$49
SP66012



52PC PITCH GAUGE METRIC/SAE

- Designed to easily identify metric and SAE thread pitch sizes
- Range: 0-25 to 6mm
- Pitch: 4 to 62

\$30
SP64037



26PC FEELER GAUGE SET TYPE A

- Metric & SAE
- 0.04 to 0.63mm & .0015" to .025"
- Straight blades 85mm long x 13mm wide
- Fold out design

\$19.95
SP64032



1/2" DR CRANKSHAFT BOLT REMOVAL TOOL

- Use where impact guns won't fit
- Loosens and tightens bolts
- Recommended for use with impact sockets
- Produces up to 600 ft/lbs of torque to loosen stubborn bolts

\$179
SP70865



TRANSMISSION STOP-OFF TOOL

- Plugs the transmission shaft opening when removing the drive shaft, repairing the U-Joints or performing general transmission service.
- Tapered Design suits most vehicles

\$14.95
SP64210





QUICK FLOW DRILL PUMP KIT

- Universal adaptor straps to all drill sizes
- 3 Litres per minute at 1,200 RPM
- Steel gear shafts running in brass bushes
- Suitable for long run cycles
- Positive Priming
- 1/4" hex to 3/8" drive drill adaptor inc.
- Quick connect couplers for hose interchange
- Also able to run using 3/8" Dr Air Ratchets

IDEAL FOR TRANSFERRING:

engine oil, automatic transmission, gear oil, power steering fluid, brake fluid, coolant, engine oil pump out, gear oil change, bilge pump out, hydraulic oils, machining coolants etc.



HIGH FLOW RATE
3 LITRES PER MINUTE
with a drill speed of 1,200RPM

HOUSED IN HEAVY DUTY CASE

\$335

SP71196

NOTE: DRILL NOT INCLUDED

TRANSMISSION ADAPTOR KIT

SUITS: QUICK FLOW DRILL PUMP

- Kit contains adaptors required to refill many sealed automatic transmissions.
- Pressure hose and adaptors have quick connect fittings for easy interchange.



SCAN ME

VISIT SPTOOLS.COM
FOR FULL LIST OF
SUPPORTED VEHICLES

\$179

SP71201



7PC DIESEL INJECTOR SEAT CLEANER SET



- Set of five diesel injector seat cleaners, centering pilot and t-handle
- Used to clean/de-carbonise injector seats when changing injectors
- Centring pilot: 7mm • Various vehicles: 15mm
- Delphi/Bosch injectors: 17 x 17mm
- Bosch injectors: 17 x 19mm
- Angled: 17 x 17mm • Angled: 17 x 21mm

\$169

SP66084



EVA TOOL STORAGE

DIESEL COMPRESSION TESTER SET AUTOMOTIVE

- Pressure Range: 0-1000psi and 0-70 Bar
- Adaptors for GM, Ford, Audi, Mercedes Benz, Peugeot, VW & Volvo
- Pressure relief valve for retesting
- A 16-1/2" wire reinforced hydraulic hose has a quick coupler on a swivel for ease of connection

\$259

SP66037



EVA TOOL STORAGE

CYLINDER LEAK DETECTOR & CRANK STOPPER

- Pinpoints low compression cause i.e. burnt valves, worn rings, etc.
- Crank stopper locks engine in place to facilitate installation of timing belts & removal of harmonic balance pulleys
- Gauges show % of cylinder leakage & cylinder pressure

\$215

SP66027



EVA TOOL STORAGE

DIESEL INJECTOR SYSTEM PRIMING PUMP

- Essential for reintroduction of fuel into fuel pump following maintenance, such as fitting of new diesel filter or following drainage of fuel tank

\$49

SP66066



MECHANICS STETHOSCOPE

- An essential diagnostic tool for fault finding in vehicle engines and engine bays, under-body, transmissions, differentials & bearings

\$39

SP62001

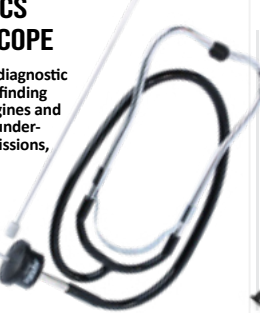

EXTRACTION SYRINGES

- Multi-purpose syringe ideal for the transfer of oils/fluids to and from vehicle components such as gearboxes and differentials.
- Translucent body allows easy inspection of oils and fluids.

MODEL	SIZE	PRICE
SP65122	200ml	\$39
SP65123	1500ml	\$79

FROM **\$39**



STRETCH BELT TOOL



- Aids in the quick removal/installation of stretch fit belts
- Compact, one-piece tool can be used on the front or back of pulley
- Allows for the reuse of stretch fit belts

\$99

SP70991



ENGINE OIL SERVICE TOOLS

MULTI DRAIN TUBS/PANS

- For use when changing engine oils, transmission oils etc
- Resistant to chemicals such as oil, antifreeze and solvents
- Heavy wall construction stays rigid even with hot oil
- Built-in pouring spout

MODEL	SIZE	DIMENSIONS	PRICE
SP64108	8 Litre	520x390x150mm	\$30
SP64116	16 Litre	600x450x180mm	\$35



FROM **\$30**

OIL FILTER WRENCH CAR STRAP TYPE

- 1/2" Square Drive
- Suits oil filters up to Ø150mm (6")
- Non-slip nylon strap

\$19

SP64010



OIL FILTER PLIERS

- Adjustable serrated jaws lock into position providing maximum grip on "oily" oil filters

- Removes oil filters: 52mm (2-18") to 127mm(5")

\$36

SP64008



ARE YOU AN APPRENTICE?

SIMPLY PURCHASE AN 'APPRENTICE CASH' MARKED PRODUCT AND RECEIVE AN ONLINE VOUCHER TO SPEND AT WWW.SPTOOLS.COM
Visit sptools.com for full terms & conditions.

REDEEMING IS QUICK AND EASY.

VISIT OUR APPRENTICE PAGE AT SPTOOLS.COM FOR MORE INFORMATION

BRAKE & CLUTCH

BRAKE MAINTENANCE PROFESSIONAL COMBO PACK

TOOLS INCLUDED

- MANUAL BRAKE BLEEDER KIT**
 - Automatically bleed brakes and refill the fluid reservoir
- STRAIGHT JAW LINE CLAMPS X2**
 - Seals 3 to 8mm flexible brake and fuel lines
- DISK BRAKE SPREADER**
 - Allows for easy compression of brake piston to aid in brake pad changes
- BRAKE FLUID TESTER**
 - Test for moisture content in the brake fluid
- BRAKE BLEEDER DOUBLE RING SPANNER SET**
 - Set Includes: 8x10mm, 9x11mm & 3/8x7/16"
- 8PC BRAKE GAUGE SET**
 - Made from 20 gauge sheet metal with durable powdercoat finish

HOT DEAL

\$249
SP63000

AUTOMATIC BRAKE FLUID RESERVOIR REFILLER

- Automatically refills brake fluid reservoir during brake bleeding
- Retaining clip provides positive clamping to all master cylinder reservoir types
- Height adjustment maintains correct fluid level; prevents running brake fluid reservoir dry
- On-off tap

\$89
SP70895



DRUM BRAKE VERNIER CALIPERS

- Graduation 0.05mm
- Locking Screw



- Jaw Length 150mm
- Inside 50-500mm
- Outside 0-500mm

\$499
SP35646

25L BRAKE & CLUTCH PRESSURE BLEEDING KIT

- Flush the entire system with one fill without the risk of running the reservoir dry



- Pressure range makes unit suitable for use with ABS systems
- Fitted with Ø42mm cap and suitable for most European models
- Additional adaptors available to expand vehicle capabilities

\$189
SP70809

EXPAND THE RANGE OF SERVICEABLE VEHICLES WITH THE ADAPTORS BELOW

ADAPTORS

SUITS SP70809

MODEL	FITS	PRICE
SP70811	Chrysler, Dodge, Jeep	\$9.00
SP70812	Most later model GM	\$19.00
SP70813	Honda Accord	\$32.00
SP70817	Ford	\$35.00
SP70818	Daihatsu	\$25.00
SP70819	Mitsubishi	\$27.00
SP70820	Nissan Blue Bird	\$25.00
SP70821	Hyundai, Mitsubishi, Nissan & Subaru	\$22.00
SP70822	Ford Escape	\$11.00
SP70823	Toyota & Lexus	\$85.00
SP70824	Aus Ford	\$85.00

UNIVERSAL CLUTCH ASSEMBLY TOOL

- Design allows easy assembly of clutch whilst on a work bench and then transfer the complete unit for installation to the vehicle
- Supplied with various collets for a range of shaft diameters



\$35
SP66050

HEAVY DUTY TUBE CUTTER

3 TO 35MM

- Use to cut tubing made of hard and soft copper, aluminium, brass, thin wall steel and stainless steel lines



\$39
SP63042

DOUBLE FLARING TOOL KIT

- Aluminium alloy casting tube cutter from 3-30mm
- Steel casing, yoke & screen bar
- 7pc adaptor

\$79
EACH

METRIC SP63015

SUITS PIPE SIZES
• 5, 6, 8, 10, 12, 14 & 16mm

SAE SP63016

SUITS PIPE SIZES
• 3/16, 1/4, 5/16, 3/8, 7/16, 1/2 & 5/8"



8PC BRAKE GAUGE SET

- Accurate measurement of the amount of brake lining that is left without guess work



COLOUR CODED

- Red: 2mm, 3mm (Pads must be replaced)
- Yellow: 4mm, 5mm, 6mm (Replacement suggested)
- Green: 8mm, 10mm, 12mm (Good condition)

\$29
SP63006

REAR DISC BRAKE TOOL

- A universal tool for winding back rear brake pistons on most vehicles



\$17.50
SP63003

DISK BRAKE SPREADER

- For easy compression of brake piston



- Suits front disc brakes on most cars and light trucks.

\$20
SP63002

3PC 75° OFFSET BRAKE BLEEDER DOUBLE RING SPANNER SET

METRIC & SAE

SET INCLUDES:
• 8x10mm,
• 9x11mm &
• 3/8x7/16"



\$59
SP10423

800ML VACUUM BRAKE BLEEDER

- Quick release locking trigger
- Universal rubber bleed screw fitting
- 700mm bleeder hose
- Compact size fits easily in the wheel area
- Universal rubber fitting holds securely on brake bleed screw
- Convenient hanging hook and quick release trigger



\$149

SP70852

SMALL LINE CLAMP SETS

- Seals flexible brake and fuel lines from 3mm to 8mm

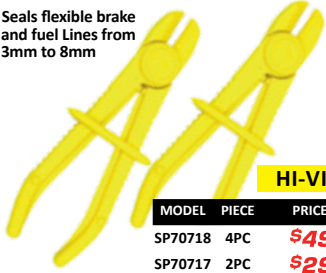

HI-VIS

MODEL	PIECE	PRICE
SP70718	4PC	\$49
SP70717	2PC	\$29

SMALL LINE CLAMP SET 4PC - 90° OFFSET

- Seals flexible brake and fuel lines from 3mm to 8mm



\$29

SP70719

BRAKE SPRING WASHER TOOL

- For removal & replacement of brake shoe retaining washers
- Head designed to fit most vehicles
- Knurled outer cone grip



\$33

SP63004

BRAKE FLUID TESTER

This compact LED brake fluid tester is a quick & effective way of testing if a vehicle's brake fluid needs replacing by showing how much moisture has been absorbed into the brake fluid.



\$95

SP63028

1/2" DR BRAKE CALIPER SPECIAL SOCKET - 10PT

- Length: 11.5 x 50mm
- High strength chrome molybdenum
- Application: Porsche, VW Touareg, Audi Q7



\$15

SP63008

3 ARM BRAKE CYLINDER HONE

- Range 19mm to 64mm
- Fitted with 28mm medium grit stones
- Adjustable tension
- Flexible Shaft



\$30

SP63036

COOLING SERVICE

HOSE CUTTERS - 42MM

PLASTIC & RUBBER



\$29

SP63043

- 42mm pipe cutter
- Compound ratchet action
- Cut PVC pipe, vacuum hoses, heater hoses etc.

HOSE CUTTERS - 75MM

PLASTIC & RUBBER

- 75mm pipe cutter
- Compound ratchet action
- Cut PVC pipe, vacuum hoses, heater hoses etc.

\$95

SP63046



COOLING SYSTEM FLUSHING GUN

\$79

SP70801



- Multi-purpose cleaning gun uses a combination of high pressure compressed air and water to quickly clean dirt, scale etc. from the cooling system
- Multi-step nozzle suits most radiator and heater hose sizes

CLIP PLIERS - 225MM

FLAT BAND

- Special "i" slot and "o" slot jaws



\$20

SP72607

- Finger tip position lock to keep hose clamps spread open

IDEAL FOR REPLACING LOWER RADIATOR HOSES AND FITS MOST SIZE CLAMPS

SWIVEL JAW

- Special "v" slot and cross slot jaws



\$20

SP72608

- Finger tip position lock to keep hose clamps spread open



COOLING SYSTEM PRESSURE TESTER

- Eliminates the need for adapters to pressure test the cooling system
- Universal attachment to radiator or header tanks
- Fits bayonet and threaded filler necks

\$279

SP70800



BRAKE PISTON REWIND KIT 18 PIECE (RH-LH)

HOT DEAL

\$135

SP63005

- Aids in the rewinding of the pistons in brake calipers without damaging the piston gaskets/seals when replacing brake pads. This is achieved by allowing for the rotation of the piston at the same time as pushing the piston back into the caliper.
- Includes both left & right handed thrust bolt assemblies
- Kit housed in heavy duty case and premium EVA foam tray

EVA TOOL STORAGE



STEERING & SUSPENSION



10PC BEARING RACE & SEAL DRIVER SET

- Designed to allow operator to install bearing cases & seals without damage
- Ideal for installing wheel bearing outer races
- 39.5mm – 81mm

\$129

SP66040

5PC BALL JOINT EXTRACTOR SET

KIT INCLUDES

- Three forks & two handles
- 24mm Ball-joint separator
- 28.5mm Pitman-arm wedge
- 18mm Tie-rod spreader
- 8" manual knurled grip handle
- 8" air-tool compatible handle with chuck collar

\$129

SP67024



BALL JOINT SEPARATOR

- For use on most cars and light trucks to remove tie rods from shock absorber links ball joint

\$22
EACH

- Constructed of drop-forged steel for long-lasting strength and durability

MODEL	SIZES
SP67020	19mm
SP67021	24mm



COIL SPRING COMPRESSOR SET - 2PC

- Wrap over coil claws for extra safety
- Uses twin prongs and works at a pressure up to 1100kgs
- Maximum jaw opening: 230mm

\$89

SP67025



PULLEY PULLER

- For removing alternator and power steering pulleys
- 28 to 46mm Opening
- 180mm Pull

\$39

SP67035



PITMAN ARM PULLER

- 1-15/16" Opening, 2-1/2" Pull
- 33mm Opening, 63mm Pull

\$39

SP67030



TIE ROD END PULLER & PITMAN ARM PULLER

- 1-1/16" opening, 1-3/4" pull
- 27mm opening, 44mm pull

\$29

SP67031



PULLERS

2 JAW/3 JAW GEAR PULLERS REVERSIBLE

- Large jaws suitable for bearings, wheels and all pulleys
- Small jaws suitable for use on the flat hole of the gear pulley

FROM **\$59**

AVAILABLE IN 4 SIZES

MODEL	SIZE	PRICE	MODEL	SIZE	PRICE
SP67013	75mm	\$59	SP67016	150mm	\$99
SP67014	100mm	\$75	SP67018	200mm	\$199



BEARING SEPARATORS

- Designed to remove bearings & gears where access is available behind the item
- Drop forged hardened alloy steel

FROM **\$49**

AVAILABLE IN 3 SIZES

MODEL	SIZE	PRICE	MODEL	SIZE	PRICE
SP67062	30-50mm	\$49	SP67064	75-105mm	\$89
SP67063	50-75mm	\$69			



14 PIECE GEAR PULLER & BEARING SPLITTER SET

- Aids in the removal of pulleys, gears and steering wheels
- Hardened and tempered, precision machined steel bolts
- Drop-forged, heat treated steel attachments
- Chrome plated and black oxide finishes
- Separates ball bearings

\$129

SP67050



UNIVERSAL KNUCKLE SPREADER MASTER KIT

SINGLE & TWIN

- Used to spread the steering knuckle to enable the removal and refitting of shock absorbers without the risk of damage to the knuckle

- VEHICLES INCLUDE: Audi, BMW, Citroën, VW, Ford, Skoda, Seat, Renault, Peugeot and most Japanese vehicles.

\$89

SP70972



SLIDE HAMMER PULLER KIT

- Ideal for many automobile works, such as pulling flange type rear axles and front wheel drive hubs
- Internal and external jaws provide a variety of combinations to pull bearings, gears and seals.

DESIGNED FOR

- Removing front and rear axles
- Removing stubborn oil seals, bearing races and other press fit parts

\$259

SP67048



THREAD & STUD REPAIR



SCREW EXTRACTOR SET DRILL BIT & GUIDE 25 PIECE

- For extracting broken screws, studs & bolts: 5mm to 16mm
- Threads designed to remove broken fasteners without breaking or jamming
- Fluted type extractors that provide a solid grip on broken studs and screws



\$69

SP31320

SCAN ME

CHECK OUT THE DEMO VIDEO

STUD REMOVAL AND INSERT SET - 28PC

- Metric & SAE Sizes
- Includes two L-Keys
- Each threads size uses one tool for removal & one for installation
- Unique design ensures damage free threads



\$99

SP31255



FLAMELESS PORTABLE INDUCTION HEATER

1750W

\$1540

SP85175

HEATS STEEL OVER
800°C
IN SECONDS

CHECK OUT THE
DEMO VIDEO



SCAN ME



- Professional induction heater with Kevlar coated coils ensure a safe, flameless working environment
- Lightweight and extremely portable (Includes shoulder strap)

**HOT
DEAL**

STUD INSTALLATION AND REMOVAL TOOL

- Suitable for various sizes of studs
- Cam rotates to grip onto the stud for quick and easy use

CAPACITY:
• 10-19mm
(3/8" - 3/4")

\$59

SP31251



4PC DEBURRING TOOL SET

- 4 Various extra fine deburring tools for a smooth finish
- Remove burrs from plastic, copper, aluminium & ferrous metal pipes
- Pocket clip



\$45

SP31340



42PC RETHREADING KIT AUTOMOTIVE

- Taps & dies are suitable for chasing out damaged threads and the removal of nicks/burrs without undercutting good threads
- Thread file restores damaged external threads on any diameter
- Right or left hand

\$189

SP31310

PANEL & TRIM

TRIM REMOVAL SET 4 PIECE

- Removes: hole plugs, window, door, sunroof & rubber joints, mirrors, windshield wipers, metal/plastic bolts and throttles.
- Lossens: stickers/decals, electrical devices and weights on aluminium alloy rims

\$29.95

SP30867



The perfect panel beating set for any workshop, featuring the most commonly used dollies & hammers - you'll be well equipped to handle the vast majority of panel repairs.

- KIT INCLUDES
- Pick & Finish Hammer
 - Standard Bumping Hammer
 - Straight Pein & Finishing Hammer
 - Double End Hand Dolly
 - Curved Dolly • Utility Dolly • Heel Dolly

\$209

SP30202

7PC PANEL BEATING SET



TRIM PANEL & SCRAPER SET 28 PIECE

- The most versatile, comprehensive, multi-purpose body/interior commercial trim removal and scraper tool set available
- Ideal for the removal of trim mounting clips and fasteners, windshield mouldings, dash removal, internal and external trims



\$99

SP30877

DOOR UPHOLSTERY CLIP REMOVER SET 2 PIECE

- Designed for the damage free removal of trim clips found on most vehicles
- Heavy duty alloy steel blades
- Durable ergonomic heavy duty handles, featuring anti-slip grip

\$29.95

SP30863

- SET INCLUDES
- Small - 5 to 7mm
 - Large - 6 to 9mm



DOOR UPHOLSTERY CLIP REMOVER U-BLADE

- Designed for the damage free removal of trim clips found on most vehicles
- Heavy duty alloy steel blade
- Durable ergonomic heavy duty handle

\$16

SP30815



**APPRENTICE
CASH**

ARE YOU AN APPRENTICE?

SIMPLY PURCHASE AN 'APPRENTICE CASH' MARKED PRODUCT AND RECEIVE AN ONLINE VOUCHER TO SPEND AT WWW.SPTOOLS.COM
Visit sptools.com for full terms & conditions.

REDEEMING IS QUICK AND EASY.

VISIT OUR APPRENTICE PAGE AT
SPTOOLS.COM FOR MORE INFORMATION

AUTO SPECIALITY

HEAVY DUTY PRY BARS

INDEXING JAW 2 PIECE

\$135

SP30870

SET INCLUDES:
• 406mm (16")
• 559mm (22")

- Industrial Strength Chrome Vanadium Steel (Cr-V) steel
- Adjustable head with up to 15 locking positions (406mm - 11 locking positions)
- Indexable to over 180° allowing more leverage in confined spaces.



180° RANGE

UP TO 15 LOCKING POSITIONS

EXTENDABLE JIMMY END

- Chrome Molybdenum (Cr-Mo) steel for strength & durability
- Angled chisel end gives greater leverage when prying
- Extendable from 570mm to 840mm (22" to 33")

- Continuous taper end for ease of alignment and adjusting
- Hexagonal 16mm shank for additional strength and durability

\$79

SP30817



EXTENDABLE

WINDSCREEN REMOVABLE TOOL

- Durable aluminium handle
- Heavy duty steel knife
- Replaceable blades
- Knurled Handle for additional grip

\$34

SP30829



HOT DEAL

REPLACEMENT BLADES AVAILABLE

- Hardened then honed blade allows fast separation of screen from bond
- Able to be re-sharpened



\$10

SP33829

O-RING & SCRIBE SET 2 PIECE

- Both tools facilitate easy removal & installation of O-rings & seals, scribing, carving & part placement
- Combination pick and hook pick
- 90° pick and straight pick

\$20

SP30808



EXHAUST PIPE & TUBING CUTTER

- Designed for cutting thin walled steel and copper tubing

\$79

SP30920



- Suitable for cutting exhaust pipe with diameters from 20-75mm

4" RAZOR SCRAPER

- Easy removal of gasket residue, carbon & ingrained dirt
- Removes decals and stickers
- Blade Size: 40mm (w)

\$17.50

SP30816



UNIVERSAL LIFT SUPPORT CLAMP

- Securely supports and locks onto gas strut shafts on bonnets, tail-gates, hatchbacks & car boots to enable worn gas struts to be fixed in the extended position

\$35

SP64220



PARTS BRUSH "BUCKET"

- "Bucket brushes" are designed for hand use in a parts washing sink or solvent container

\$39

SP30895



PARTS BRUSH "FLOW-THROUGH"

- "Flow-Through" brushes are designed for parts washing sinks with circulating solvent system

\$49

SP30896



WIRE BRUSH SETS 3 PIECE

- Ideal for heavy duty cleaning
- Ergonomic polypropylene handles
- Carbon Steel Bristled Brush
- Stainless Steel Bristled Brush
- Brass Bristled Brush

AVAILABLE IN 2 SIZES

MODEL	SIZE	PRICE
SP30892	254mm	\$15.00
SP30893	355mm	\$15.95



HOOK & PICK SETS - 4PC

REGULAR

- INCLUDES:
- Awl tool
 - 45° tool
 - 90° tool
 - Hook tool

\$19.95

SP30802



EXTRA LONG

- Heavy duty alloy steel blades - 400mm
- Heavy duty handles with comfort grip
- 1x Rubber hook
- 1x Glass run cleaner
- 1x Angular hook
- 1x Long hook

\$59

SP30842

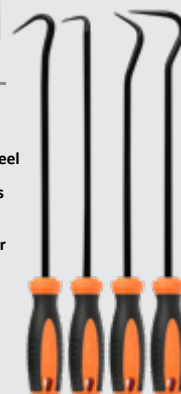

STAINLESS STEEL SCRAPER SET 3 PIECE

- Precision ground blades
- Heavy duty timber handles
- 10, 15 & 23mm blades

\$59

SP30805



SCRAPER AND REMOVER SET - 5 PIECE

- 11" Multi-purpose scraper
- 8-1/4" Multi-purpose scraper
- 8" Scratch awl
- 9" Cotter pin puller
- Radiator hose remover

\$59

SP30865



POLY SCRAPER SET 4 PIECE

- Includes 20, 22, 25 & 38mm scrapers
- Tough composite construction
- Remove decals, mouldings, emblems, gaskets & wheel weights from cars without damaging the vehicle

\$25

SP30813



PICK UP TOOLS

EASILY RETRIEVE SMALL, HARD TO REACH OBJECTS



MAGNETIC PICK-UP TOOL - TELESCOPIC

- Magnetic telescope will hold 1kg
- Extends 130 to 620mm
- Pen type

\$19.95
SP31500

EXTENDABLE

MAGNETIC PICK-UP TOOL - TELESCOPIC WITH CLEANING NEEDLE

- Magnetic telescope will hold 1kg
- Needle will hold 500g
- Extends 130 to 620mm
- Pen type

\$9.95
SP31507

EXTENDABLE

MAGNETIC PICK-UP TOOL - TELESCOPIC

- Strong & lightweight stainless steel shaft
- PVC comfortable cushion handle
- Pocket clip

FROM \$14.95

MODEL	KG PICK-UP	EXT. LENGTH	Price
SP31502	1kg Lift	185 - 840mm	\$14.95
SP31503	2.3kg Lift	180 - 800mm	\$19.95

INSPECTION MIRROR & PICK-UP TOOL SET 4 PIECE

SWIVEL HEAD TELESCOPIC MIRROR:

- Extends 250-925, Ø 57mm

TELESCOPIC PICK UP TOOL:

- Extends 160-645mm

\$35
SP31490

3X INTERCHANGEABLE MAGNETIC HEADS

- 1.5kg swivel head pick up tool
- 1.5kg pick up tool
- 0.5kg pick up tool

MEASURING

DIGITAL FLEX HEAD TORQUE WRENCH

ONE-STEP TORQUE-ANGLE

- Flex Head Ratchet - The ultimate in confined space convenience
- Range selection: Nm, in-lb, ft-lb, kg-cm, etc.
- Calibrated for both Clockwise and Anti-Clockwise use
- Warning LED's and audible alarm sounds within 10% of target value

\$849
SP35256

3/8" FLEX HEAD
6.8 to 135Nm
425mm

DIGITAL DISPLAY

TORQUE TARGET ALARM
Visual and Audio

- Automatic torque value compensation for flex head angle deviation
- Selectable Torque Functions: Peak mode & Tracking mode
- Angle function: 0° to 360°

MICROMETER TORQUE WRENCHES

- Click type signal alerts user when the required torque is reached
- Reversible ratchet (clockwise torque only)
- Scale Adjuster - accurate & easy adjustment

TORQUE TARGET ALARM
Audible click for when torque target is reached

- Adjuster lock will hold required setting during use
- Easy readable scale convex lens enlarges well defined, bold scale numbering. (Nm scale only)
- Quick release mechanism

MODEL	DRIVE	LENGTH	RANGE	PRICE
SP35152	1/4"	323mm	5-25Nm	\$169
SP35252	3/8"	400mm	20-100Nm	\$199
SP35352	1/2"	517mm	40-200Nm	\$209
SP35353	1/2"	517mm	60-340Nm	\$229
SP35473	3/4"	1210mm	150-750Nm	\$949

DIGITAL TORQUE WRENCHES

- Digital display
- Digital torque value readout
- 50 Data sets of memory capacity
- Reversible ratchet head - counter clockwise & clockwise torque capable

DIGITAL DISPLAY

TORQUE TARGET ALARM
Visual and Audio

- 2 LED indicator for pre-settable target torque
- Range selection: Nm, ft-lb, in-lb, kg-cm
- 72 Gear teeth
- Standard functions: Torque, measurement & mode settings.

MODEL	DRIVE	LENGTH	RANGE	PRICE
T835252	3/8"	380mm	27-135Nm	\$239
T835355	1/2"	480mm	40-200Nm	\$249

STAINLESS STEEL RULERS - METRIC/SAE - INDIVIDUAL

High quality hardened stainless steel rulers • Double sided with hang hole • Permanently etched graduations in both mm and inches

150MM/6"	300MM/12"	600MM/24"	1000MM/40"
\$6.50	\$13	\$18	\$33
SP35211	SP35213	SP35215	SP35217

DIAL INDICATOR

- 0-10mm dial indicator
- Graduation: 0.01mm
- Hardened, lapped stainless steel stem and spindle
- High sensitivity, stable and reliable accuracy

\$90
SP35691

- Easy-to-read crisp graduations
- 8mm shank diameter
- Diameter of bezel: 60mm

MAGNETIC STAND ADJUSTABLE

SUITS DIAL INDICATORS

- Attaches horizontally or vertically to flat surfaces
- V groove base mounting on cylindrical surfaces
- Fine adjust arm and solid knobs
- Flexible, precise rotary joints adjust any direction

\$59
SP35697

- Powerful magnetic base with on/off switch
- 60kg magnetic pulling force

ANGULAR TORQUE GAUGE - 1/2" DR

- 360° scale (Dial Pointer)
- Allows correct tensioning of fasteners by degrees of torque
- Can be used for all torque-to-yield applications

\$38
SP35360

VERNIER CALIPERS

- Graduation 0.02mm/0.0001"
- 4-way measurement - Inside, outside, step & depth
- Slider provides smooth, stable and comfortable operation
- Metric & SAE measurement

\$59
SP35607

\$79
SP35608

TELESCOPIC GAUGE SET 6 PIECE

- Range 8-150mm, 5/16"-6"
- For quick and accurate measurement of bore diameters
- Hardened stainless steel automatic self-centring plungers
- Locks on any setting by turning knob at the end of the handle
- Spring loaded cylinders

\$89
SP64066

COMPRESSORS

2HP PORTABLE AIR COMPRESSOR UTE PACK

Built tough & compact - Ideal for mobile applications - Fits under Tonneau style ute lids



3 YEAR PUMP WARRANTY	DIRECT DRIVE
2.0 HP	10 AMP
10 LITRE TANK	226L/MIN FAD

\$495
SP11-12X

PORTABLE CAST IRON AIR COMPRESSORS V-TWIN

2.5 HP	10 AMP
60 LITRE TANK	260L/MIN FAD

\$995

SP14

3 HP	10 AMP
60 LITRE TANK	318L/MIN FAD

\$1095

SP17

- Built tough & compact - Ideal for mobile applications.
- Fits under Tonneau style ute lids



3 YEAR PUMP WARRANTY

2HP PORTABLE AIR COMPRESSOR TRADE QUALITY

- Lightweight & high trade quality
- Larger tank capacity
- One-touch (Nitto style) connector



2.5 HP
36 LITRE TANK
10 AMP
126L/MIN FAD

\$495 **3 YEAR PUMP WARRANTY**

DIRECT DRIVE

2.5HP PORTABLE AIR COMPRESSOR TRADE QUALITY

- The ultimate builders companion
- Able to run all nail guns
- One man lift



2.5 HP
50 LITRE TANK
10 AMP
260L/MIN FAD

\$649

DIRECT DRIVE

2.2HP PORTABLE CAST IRON V-TWIN AIR COMPRESSOR

- Ideal for the builders gang
- Will run several air tools at once
- One-touch (Nitto style) connector



2.2 HP
50 LITRE TANK
10 AMP
194L/MIN FAD

\$895

BELT DRIVE

3HP TRIPLE CAST IRON PORTABLE AIR COMPRESSORS 15AMP

- Ideal for commercial applications
- Full brass non-return valve
- Copper delivery pipe
- 200mm (8") solid rubber wheels
- One-touch (Nitto style) connector
- Certified safety valve
- Large oil level sight glass
- Soft start valve
- Copper wound motor
- Cast iron cylinders
- Resettable overload protection



MODEL	HP	TANK	FAD	PRICE
SP18	3	60L	385L/min	\$1350
SP1800	3	100L	385L/min	\$1495

EASY CREDIT

BELT DRIVE

CAST IRON STATIONARY AIR COMPRESSORS 3 PHASE - 15AMP

- Ideal for commercial applications
- High efficiency induction motor
- Full brass non-return valve
- Copper delivery pipe
- Independent 3 phase switch box operates by a single phase pressure switch
- One-touch (Nitto style) connector
- Resettable overload protection



MODEL	HP	TANK	FAD	CAST	PRICE
SP25	5.5	200L	508L/min	V-Twin	\$2995
SP35	7.5	270L	880L/min	Triple	\$3950
SP50	10	270L	1360L/min	Triple	\$4500

COMMERCIAL GRADE

BELT DRIVE

15M RETRACTABLE AIR HOSE WALL MOUNTABLE

- Heavy duty hose extreme flex hose
- Steel bracket included to firmly fix the reel to a surface of your choice
- Max working pressure: 300psi (20bar)



\$149

- One touch Nitto style couplers

SPHR15

PREMIUM FITTED AIR HOSE

Made from an engineered hybrid polymer that provides superior all weather flexibility.

- Hose will not kink when under pressure.
- One-touch Nitto™ style
- Swaged hose clamps
- 10mm / 3/8" I.D
- UV treated

MODEL	SIZE	PRICE
SP66-15N	15m	\$59
SP66-30N	30m	\$89



EXTREME FLEXIBILITY

ANTI-KINKING TECHNOLOGY

FROM **\$55**

RECOIL HOSES

- 1/4" BSF
- 2x Male Threads
- Max Pressure: 165PSI



FROM **\$39.95**

MODEL	LENGTH	PRICE
SX-806	6 METRES	\$39.95
SX-809	9 METRES	\$45.00
SX-815	15 METRES	\$65.00

28 **DON'T BUY AN INFERIOR PRODUCT**



Air Compressor Rating in accordance with **AUSTRALIAN STANDARD AS 4637-2006**

AIR TOOLS

46 YEARS OF TRUSTED QUALITY ★★★★★

3/4" DR IMPACT WRENCH

8 VANE MOTOR

\$599

SP-1157

- Bolt Busting Torque: 1900Nm
- Induction hardened, industrial single jumbo dog hammer mechanism
- 5 torque settings

HIGH PERFORMANCE MOTORSPORT MOTOR

1/2" DR IMPACT WRENCH PLUS BONUS 3/8" DR LONG NECK RATCHET WRENCH

\$349

SP-1140EXB

- 1/2" DR IMPACT WRENCH
- Bolt Busting Torque: 1140Nm
- 3/8" DR RATCHET WRENCH
- Max Torque: 30 ft-lbs
- Free Speed: 230rpm

NORMALLY **\$295**

1/2" DR IMPACT WRENCH

COMPACT

- Bolt Busting Torque: 970Nm
- 93mm Head (including anvil). Perfect for hard to reach and confined areas
- Ideal for mechanical workshops
- Single dog hammer mechanism
- 3 torque settings

\$199

SP-1142



HOT DEAL

93MM
(Including anvil)

970Nm
BOLT BUSTING TORQUE

3/8" DR MINI RATCHET WRENCH

- Max Torque: 30 ft-lbs
- Free Speed: 230rpm

\$129

SP-1763

RATCHET WRENCH

AVAILABLE IN 3/8" & 1/2"

- Free Speed: 200rpm
- Max Torque: 61Nm

3/8" SP-1139

1/2" SP-1139-2

\$139

EACH

1/4" LONG NOSE DIE GRINDER STRAIGHT

EXTENDED

- RPM: 21,000
- Length: 259mm

- Direct drive motor with a graduated trigger
- Safety throttle lever

\$197

SP-7210L

1/4" HEAVY DUTY DIE GRINDER STRAIGHT

- Free speed: 20,000rpm
- Direct drive motor
- Graduated trigger
- Soft grip body

\$145

SP-7220

1/4" IMPACT SCREWGUN PISTOL

\$139

SP-7146H

- Free speed: 11,150rpm
- Working Torque: 340Nm
- Capacity: 6.35mm
- Air consumption: 647L/min Max

3/8" DR KEYLESS DRILL REVERSIBLE

\$169

SP-1529

- Free Speed: 2,200RPM
- Length: 175mm
- Geared keyless chuck (2 gear, caged)
- High quality aluminium body

PNEUMATIC/HYDRAULIC RIVETER

- 3 Jaw clamping chuck for increased grip & extended jaw life
- Sets 2.4, 3.2, 4.0 & 4.8mm (3/32", 1/8", 5/32" & 3/16") rivets on all materials (aluminium, steel & stainless steel)

\$159

SP-TAR40

10MM BELT SANDER

- RPM: 16,000
- Cap: 10x330mm
- Length: 275mm
- 360° adjustable sanding arm
- Graduated trigger

\$199

SP-2370

SCORPION

7PC AIR BRUSH KIT

- 140mm long air brush
- 600mm hose
- 2x 50ml glass pots
- Lightweight & compact

\$19.95

SX-05

- Pot size: 1L
- Max pressure: 50PSI
- Nozzle size: 1.8mm

\$69

SX60-2

HIGH PRESSURE SPRAY GUN

HIGH PRESSURE SPRAY GUN DELUXE

- Pot Size: 250ml
- Max Pressure: 50PSI
- Air Con: 185L/min Max
- 77L/min Avg

\$39

SX-30

GRAVITY FED SPRAY GUN

AVAILABLE IN 2 NOZZLE SIZES

- Pot size: 600ml
- Max pressure: 50PSI

1.4MM SX50-1

2.0MM SX50-3

\$59

EACH

OWN QUALITY TOOLS AND EQUIPMENT TODAY AND PAY THEM OFF WEEKLY!

REPAYMENTS START FROM ONLY \$8 PER WEEK



EASY CREDIT

SP EASY CREDIT CAN HELP YOU FINANCE YOUR SP TOOLS PURCHASE OVER THE COMBINED VALUE OF \$1000 AND REPAYMENTS START FROM AS LITTLE AS \$8 PER WEEK*. APPLY NOW AT SPTOOLS.COM

WORKSHOP GEAR

MECHANICS CREEPERS

HEAVY DUTY

- Heavy duty steel frame
- 6 heavy duty wheels
- Padded body & head rest
- 1030mm x 440mm

1030mm



\$119

SPR-44



440mm

FAST BACK

IDEAL FOR WORK ON TRUCKS & BUSES

- Ultra stable three wheel configuration
- Ergonomic shape
- Heavy duty HDPE shock proof body
- 3" twin axis sealed bearing control caster
- 7" dual bearing all-terrain wheels
- Built-in tool trays
- Soft Polyurethane headrest
- 2 Position ground clearance (Ultra Low & Off Road)
- Capacity: 225Kg (500 lbs)
- 1040 x 570 x 230mm

CHECK OUT THE PRODUCT VIDEO



SCAN ME



\$349

SPR-78



SPRAY CLEANING GUN 1 LITRE

FLEXIBLE

- PE tank and tube with adjustable spray/jet nozzle
- Flexible tube
- Lance with adjustable nozzle with cone
- Capacity: 1 Litre

\$89

SP65012

SPRAY CLEANING GUN 1 LITRE

- PE tank and tube with adjustable spray/jet nozzle
- Lance with adjustable nozzle with cone
- Capacity: 1 Litre

\$79

SP65011



FLUID TRANSFER & LUBRICATION

MULTIPURPOSE PUMP 1 LITRE

- Great for top up jobs - quicker and easier
- Ideal for topping up difficult to access oiling points on motor vehicles, lawn mowers, chain saws, outboard and two stroke motors, and other odd jobs around the workshop and home

\$35

SP65155



DRUM PUMP 20 LITRE

- Ideal for transferring non-corrosive fluids of light to medium viscosity, such as engine oil, gear oil, transmission fluid, machine oil, etc.
- Flow: 60ml / stroke

\$65

SP65156



SPRING GEAR OIL PUMP 20 LITRE

- Ideal for transferring non-corrosive fluids of light to medium viscosity, such as engine oil, transmission fluid, gear oil, machine oil, etc.

\$159

SP65160



- Spring operated pump and unique swivelling pump head assembly allows the hose to follow the operator
- Flow: 300ml / stroke
- Suction tube length: 325mm

VARIABLE STROKE GREASE GUN

- 20" flexible hose with heavy duty quick release coupler
- In-line swivel joint
- Cast aluminium body
- Hardened 4 jaw super grip coupler
- Bleeder valve for purging air
- 2-way loading: Bulk or 450cc grease cartridge

QUICK RELEASE COUPLER

\$159

SP65108



TYRE SERVICE

AIR HOSE CHUCK CLIP-ON

ANGLE

- Open 1/4 BSP
- High quality solid brass clip-on air chuck

\$19

SP65531



TYRE CHUCK DUAL HEAD

- Lightweight zinc/brass body
- Comfortable high grip rubber handle
- 1/4" Female thread

- Dual head design for dual wheel vehicles

\$25

SP65535



TYRE INFLATOR AUTO STYLE

SCORPION

\$29

S-880

- Auto Style Inflator
- Dial Type Gauge Displays Bar, kPa, PSI, Kg/cm²
- High Quality Construction



PROFESSIONAL TYRE INFLATOR WITH DEFLATOR

DUAL HEAD

DIGITAL DISPLAY

- Pressure measuring range: 0-160PSI (+/- 2% @25C)
- Dual chuck
- Operating pressure: 90PSI
- Air Flow: 1.2CFM at 100PSI

\$199

SP65510



SHOP VACS

COMMERCIAL WET & DRY VACUUM/BLOWERS

\$275

\$149

1400W SP040

- 40L stainless steel container
- Wet and dry vacuum cleaner
- Built-in easy drainage system
- Swivel castors and large rear wheels provide ease of movement in any direction
- Filtered intake and outlet exhaust

1250W SP020

- 20L Stainless steel container
- Easily converts to power blower
- Swivelling castors provide convenient multi-direction movement
- On board accessories storage



40 LITRE

20 LITRE



GENERATORS

6.5HP INDUSTRIAL SERIES GENERATOR



\$695
2.8 KVA
PULL START
SPG2800 2X 15A OUTLETS

10HP CONSTRUCTION SERIES GENERATOR



DIESEL POWERED

\$3100
6.8 KVA
PULL START
WHEEL KIT INCLUDED
SPGD6800E 2X 15A OUTLETS

INVERTER GENERATORS

ECO FRIENDLY SUPER QUIET

Powerful, compact and with a super quiet running noise, the range of SP Inverter generators are ideal for all camping and leisure activities.



\$995
2500W
4 LITRE TANK
PULL START
SPGi3000 2X 15A OUTLETS

\$895
1800W
4 LITRE TANK
PULL START
SPGi2000 1X 15A OUTLETS

PRESSURE WASHERS

ELECTRIC PRESSURE WASHER 1740PSI DOMESTIC



- Max Pressure: 1740psi
- Flow Rate: 6.5 Litres p/min
- Power: 1400w

INCLUDES:

- Trigger
- Variable spray nozzle lance
- Turbo nozzle lance
- Extension lance
- 5m high pressure hose with quick connect
- Detergent bottle
- Transparent water filter

\$175
AR120

ELECTRIC PRESSURE WASHER 2030PSI HEAVY DUTY



- Max Pressure: 2030psi
- Flow Rate: 7.3 Litres p/min
- Power: 2000w

INCLUDES:

- Trigger
- Turbo nozzle lance
- Variable spray nozzle lance
- Rotary brush
- 8m high pressure hose with quick connect
- Removable built-in detergent tank
- Transparent water filter

\$395
SP140

HOT DEAL

PETROL POWERED PRESSURE WASHER 2500PSI DOMESTIC



- 2500 Max PSI
- 9.7L/min
- 5.5Hp Torini Engine
- Brass head 3 axial piston pump

INCLUDES:

- Full metal lance with quick connect
- 5 quick connect nozzles - 0°, 15°, 25°, 40° & detergent nozzles
- 8m textile braided hose
- Inlet water filter

\$499
SP250P

POWERED BY
TORINI
INDUSTRIAL ENGINES

OWN QUALITY TOOLS AND EQUIPMENT TODAY AND PAY THEM OFF WEEKLY!



SP EASY CREDIT CAN HELP YOU FINANCE YOUR SP TOOLS PURCHASE OVER THE COMBINED VALUE OF \$1000 AND REPAYMENTS START FROM AS LITTLE AS \$8 PER WEEK*. APPLY NOW AT SPTOOLS.COM

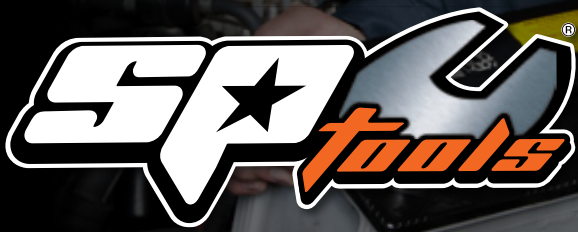

SMART MULTI-VOLT BATTERY CHARGERS

- Built-in microchip charging control and monitoring system
- Overcharge protection, protecting the battery from damage due to overcharging
- Reverse polarity, short circuit, overload and high temperature protection
- LED indicators showing battery voltage, current and charging status

VISIT SPTOOLS.COM FOR FULL LIST OF FEATURES

NEW



8 STAGE 3.5 AMP SMART CHARGER MULTI VOLT - 6 & 12V

LEAD ACID, AGM & LITHIUM

- Current Output: 3.5 Amp
- Output Voltage (Nom): 6 & 12V
- Charge Stages: 8 Stages

\$99

SP61075

8 STAGE 26 AMP SMART CHARGER MULTI VOLT - 6, 12 & 24V

LEAD ACID, GEL, AGM & LITHIUM

- Current Output: 26 Amp
- Output Voltage (Nom): 6, 12 & 24V
- Charge Stages: 8 Stages

\$299

SP61086

18V BRUSHLESS COMBO KIT

KIT INCLUDES

- 18v 1/2" Dr impact wrench
- Speed: 2200rpm
 - Torque: 970Nm

- 18v 1/4" Hex Impact Driver
- 3 Speeds
 - 2 Torque Settings

- 18v Cut Off / Angle Grinder
- Brushless
 - Torque: 7000rpm

\$995

SP82233



INCLUDES 2X 5.0AH BATTERY PACKS & CHARGER

WORKSHOP SEAT 3 DRAWERS 888 SERIES

- 370 x 400 x 367mm
- High density foam padded seat
- Ball bearing slide drawers
- Easy access spray can holder
- Swivel castors

\$135

T8R58



DIGITAL MULTIMETER

- Continuity
- Back Light
- Data Hold
- AC/DC Voltage
- DC Current
- Resistance
- Diode Test
- Transistor Test

CAT II **\$35**
600V

SP62012



CAN OBDII/EODB SCANNER CODE READER

READS & CLEARS GENERIC & MANUFACTURER SPECIFIC DIAGNOSTIC TROUBLE CODES (DTC'S) & TURNS OFF CHECK ENGINE LIGHT.

Covers all OBDII compliant vehicles: Made in USA from 1996 on; Made in Europe petrol 2001 on & diesel 2004 on; Made in Australia or New Zealand from 2006 on.

MAKE SURE YOUR VEHICLE IS CAN OBDII/EODB COMPLIANT BEFORE PURCHASING

\$79

SP61150



YOUR LOCAL STORE:

Carrum Downs
03 9770 8400
sales@boltsgalore.com.au

BOLTS GALORE

pakenham@boltsgalore.com.au

Pakenham
03 5941 9000

While Austech Industries makes every reasonable effort to ensure the accuracy and validity of the information provided. Pricing and specifications are continually changing, Austech Industries reserves the right to change at any time without notice, the information contained in our Trade Catalogues, Promotional Brochures, Catalogues and all such print media, and makes no warranties or representations as to its accuracy.

All prices include GST. Not all products in this brochure are available from all outlets. Prices may vary in some country areas due to freight costs. All products in this brochure were available at the time of printing. Austech Industries will do everything possible within reason, to maintain stocks of products advertised but cannot be responsible for unforeseen shortfalls beyond their control. E & OE Copyright. WWW.SPTOOLS.COM
Please note: Images are for illustration purposes only, contents and colours may vary.